

# JVC



## DIGITAL VIDEO CAMERA

# GR-DVX2

Please visit our CyberCam Homepage on the World Wide Web and answer our Consumer Survey (in English only):

<http://www.jvc-victor.co.jp/index-e.html>

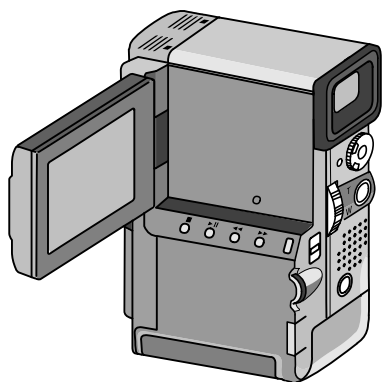

Mini **DV** PAL

## INSTRUCTIONS



### CONTENTS

<b>ABOUT DV</b>	<b>5</b>
<b>PROVIDED ACCESSORIES</b>	<b>6</b>
<b>GETTING STARTED</b>	<b>8</b>
Charging The Battery Pack .....	8
Installing The Battery Pack .....	9
Indoor Use .....	10
Using The Power Pack .....	10
Date/Time Settings .....	11
Loading/Unloading A Cassette .....	12
Recording Mode Setting .....	13
Hand Strap Attachment .....	14
Using The Soft Camera Case .....	14
Grip Strap Attachment .....	15
Tripod Mounting .....	15
Dioptre Adjustment .....	16
Remote Control Unit .....	17
Operation Mode .....	18
<b>RECORDING</b>	<b>19</b>
Basic Recording .....	19
Advanced Features .....	25
<b>PLAYBACK</b>	<b>49</b>
Basic Playback .....	49
Advanced Features .....	50
Playback Menu .....	52
Basic Connections .....	54
<b>EDITING</b>	<b>58</b>
Dubbing .....	58
Brand Setting .....	59
Random Assemble Editing .....	60
For More Accurate Editing .....	63
Audio Dubbing .....	65
Insert Editing .....	66
<b>TROUBLESHOOTING</b>	<b>67</b>
<b>AFTER USE</b>	<b>72</b>
<b>CONTROLS, INDICATIONS AND CONNECTORS</b>	<b>73</b>
Camcorder .....	73
Docking Station .....	75
LCD Monitor/Viewfinder Indications	
During Recording .....	76
LCD Monitor Indications During Playback .....	77
Warning Indications .....	78
<b>CAUTIONS</b>	<b>79</b>
<b>SPECIFICATIONS</b>	<b>81</b>
<b>GLOSSARY OF TERMS</b>	<b>82</b>
<b>INDEX</b>	<b>83</b>

**Dear Customer,**

Thank you for purchasing this Digital Video Camera. Before use, please read the safety information and precautions contained in the following pages to ensure safe use of this product.

**Using This Instruction Manual**

- All major sections and subsections are listed in the Table Of Contents (☞ cover page).
- Notes appear after most subsections. Be sure to read these as well.
- Basic and advanced features/operation are separated for easier reference.

**It is recommended that you . . .**

.... refer to "Controls, Indications and Connectors"

(☞ pgs. 73 – 78) and familiarize yourself with button locations, etc. before use.

.... read thoroughly the Safety Precautions that follow. They contain extremely important information regarding the safe use of your new camcorder.

You are recommended to carefully read the cautions on pages 79 and 80 before use.

# SAFETY PRECAUTIONS

**IMPORTANT****Connection to the mains supply in the United Kingdom.****DO NOT cut off the mains plug from this equipment.**

If the plug fitted is not suitable for the power points in your home or the cable is too short to reach a power point, then obtain an appropriate safety approved extension lead or consult your dealer.

**BE SURE to replace the fuse only with an identical approved type, as originally fitted, and to replace the fuse cover.**

If nonetheless the mains plug is cut off ensure to remove the fuse and dispose of the plug immediately, to avoid a possible shock hazard by inadvertent connection to the mains supply. If this product is not supplied fitted with a mains plug then follow the instructions given below:

**DO NOT** make any connection to the Larger Terminal coded E or Green.

The wires in the mains lead are coloured in accordance with the following code:

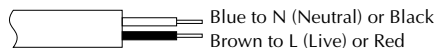

If these colours do not correspond with the terminal identifications of your plug, connect as follows:

Blue wire to terminal coded N (Neutral) or coloured black.

Brown wire to terminal coded L (Live) or coloured Red.

If in doubt — consult a competent electrician.

**CAUTIONS:**

- To prevent shock, do not open the cabinet. No user serviceable parts inside. Refer servicing to qualified personnel.
- When you are not using the AC Power Adapter/Battery charger for a long period of time, it is recommended that you disconnect the power cord from AC outlet.

**WARNING:****TO PREVENT FIRE OR SHOCK HAZARD, DO NOT EXPOSE THIS UNIT TO RAIN OR MOISTURE.****Warning on lithium cell battery**

The battery used in this device may present a fire or chemical burn hazard if mistreated. Do not recharge, disassemble, heat above 100°C (212°F) or incinerate.

Replace battery with Panasonic (Matsushita Electronic), Sanyo or Maxell CR2025; use of another battery may present a risk of fire or explosion.

- Dispose of used battery properly.
- Keep away from children.
- Do not disassemble and do not dispose of in fire.

**CAUTION (applies to the Docking Station):**  
TO REDUCE THE RISK OF FIRE, DO NOT REMOVE COVER (OR BACK). NO USER-SERVICEABLE PARTS INSIDE. REFER SERVICING TO QUALIFIED SERVICE PERSONNEL.

### NOTES:

- The rating plate (serial number plate) and safety caution are on the bottom and/or the back of the main unit.
- The rating plate (serial number plate) of the AC Power Adapter/Charger is on its bottom.
- The rating plate (serial number plate) of the Docking Station is on its bottom.

This camcorder is designed to be used with PAL-type colour television signals. It cannot be used for playback with a television of a different standard. However, live recording and LCD monitor/viewfinder playback are possible anywhere. Use the BN-V907U battery pack and, to recharge it, the provided multi-voltage AC Power Adapter/Charger. (An appropriate conversion adapter may be necessary to accommodate different designs of AC outlets in different countries.)

This unit is produced to comply with Standard IEC Publ. 65.

Mini **DV** PAL

- This camcorder is designed exclusively for the Mini DV digital video cassette. Only cassettes marked Mini DV can be used with this unit.

Before recording an important scene . . .

- .... make sure you only use cassettes with the Mini DV mark.
- .... remember that this camcorder is not compatible with other digital video formats.
- .... remember that this camcorder is intended for private consumer use only. Any commercial use without proper permission is prohibited. (Even if you record an event such as a show, performance or exhibition for personal enjoyment, it is strongly recommended that you obtain permission beforehand.)

## SOME DO'S AND DON'TS ON THE SAFE USE OF EQUIPMENT

This equipment has been designed and manufactured to meet international safety standards but, like any electrical equipment, care must be taken if you are to obtain the best results and safety is to be assured.

- DO** read the operating instructions before you attempt to use the equipment.
- DO** ensure that all electrical connections (including the mains plug, extension leads and interconnections between pieces of equipment) are properly made and in accordance with the manufacturer's instructions. Switch off and withdraw the mains plug when making or changing connections.
- DO** consult your dealer if you are ever in doubt about the installation, operation or safety of your equipment.
- DO** be careful with glass panels or doors on equipment.
- DON'T** continue to operate the equipment if you are in any doubt about it working normally, or if it is damaged in any way — switch off, withdraw the mains plug and consult your dealer.
- DON'T** remove any fixed cover as this may expose dangerous voltages.
- DON'T** leave equipment switched on when it is unattended unless it is specifically stated that it is designed for unattended operation or has a standby mode. Switch off using the switch on the equipment and make sure that your family knows how to do this. Special arrangements may need to be made for infirm or handicapped people.
- DON'T** use equipment such as personal stereos or radios so that you are distracted from the requirements of road safety. It is illegal to watch television whilst driving.
- DON'T** listen to headphones at high volume, as such use can permanently damage your hearing.
- DON'T** obstruct the ventilation of the equipment, for example with curtains or soft furnishings. Overheating will cause damage and shorten the life of the equipment.
- DON'T** use makeshift stands and NEVER fix legs with wood screws — to ensure complete safety always fit the manufacturer's approved stand or legs with the fixings provided according to the instructions.
- DON'T** allow electrical equipment to be exposed to rain or moisture.
- ABOVE ALL**
  - NEVER let anyone especially children push anything into holes, slots or any other opening in the case — this could result in a fatal electrical shock;
  - NEVER guess or take chances with electrical equipment of any kind — it is better to be safe than sorry!

## SAFETY PRECAUTIONS

Do not point the lens or the viewfinder directly into the sun. This can cause eye injuries, as well as lead to the malfunctioning of internal circuitry. There is also a risk of fire or electric shock.

**CAUTION!** The following notes concern possible physical damage to the camcorder and to the user.

When carrying, be sure to always attach and use the provided hand strap. Hold the camcorder firmly in your hand, with the strap securely around your wrist. Carrying or holding the camcorder by the viewfinder and/or the LCD monitor can result in dropping the unit, or in a malfunction.

Take care not to get your finger caught in the cassette cover. Do not let children operate the camcorder, as they are particularly susceptible to this type of injury.

Do not use a tripod on unsteady or unlevel surfaces. It could tip over, causing serious damage to the camcorder.

**CAUTION!** Attaching the camcorder to the Docking Station, connecting cables (AUDIO/VIDEO, S-VIDEO, Editing, DC) and leaving the unit on top of the TV is not recommended, as tripping on the cables will cause the camcorder to fall, resulting in damage.

### About Batteries

**DANGER!** Do not attempt to take the batteries apart, or expose them to flame or excessive heat, as there is a risk of fire or explosion.

**WARNING!** Do not allow the battery terminals, or the battery itself, to come in contact with metals, as this can result in a short circuit and possibly start a fire.

- When transporting, make sure the provided battery cap is attached to the battery. If you misplace the battery cap, carry the battery in a plastic bag.

### The Benefits Of Lithium-Ion Batteries

Lithium-ion battery packs are small but possess a large power capacity. However, when the battery pack becomes cool in an environment subject to cold temperatures (below 10°C/50°F), the battery pack has a characteristic that its usage time becomes shorter and may cease to function. If this happens, place the battery pack in your pocket or other warm, protected place for a short time, then re-attach it to the camcorder. As long as the battery pack itself is not cold, it should not affect performance.

(If you're using some kind of heating pad, make sure the battery pack does not come in direct contact with the pad.)

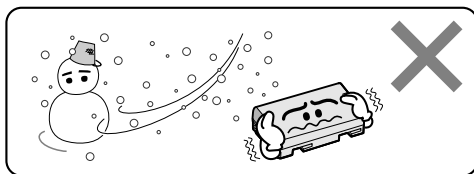

**Lithium-ion is vulnerable in colder temperatures.**

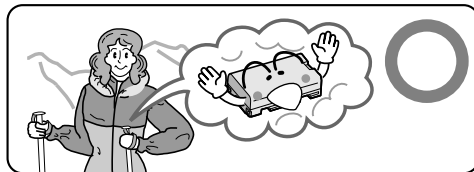

The digital video camera converts incoming audio and video signals into digital form for recording.

A video signal is composed of a luminance signal (Y) and colour signals (R-Y and B-Y). These signals are identified and recorded digitally (Digital Component Recording). The A/D (Analogue to Digital) converter samples the Y signal at 13.5 MHz, and R-Y and B-Y at 6.75 MHz, and changes them to an 8-bit quantum signal.

Sound sampled at 48 kHz is changed to a 16-bit quantum signal, and sound sampled at 32 kHz is converted to a 12-bit signal.

## NOTE:

*The data recorded on a tape is digital, but the output of the this camcorder is analogue.*

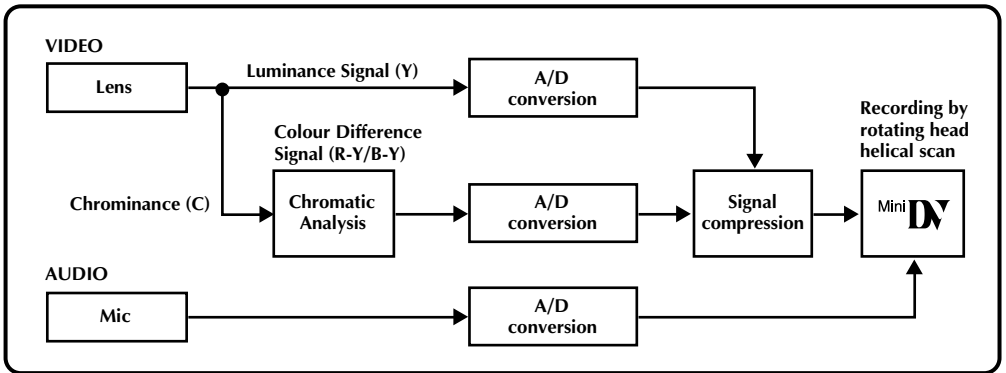

This camcorder separates the data into blocks, writing one block of each data type on each track of the tape.

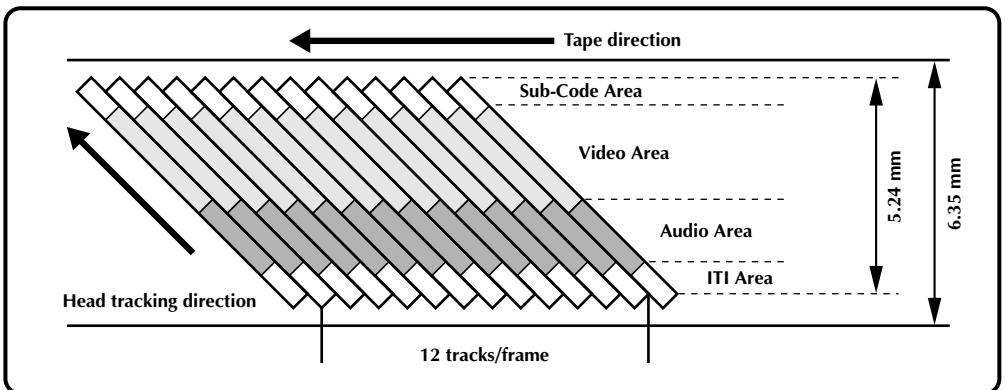

### 1 Sub-Code Area

The Time Code and Date/Time data are written here, separate from the video data. This enables you to display the date and time during playback, even if they weren't displayed while recording.

### 2 Video Area

The digital video signal is recorded here.

### 3 Audio Area

The digital audio signal is recorded here.

### 4 ITI (Insert and Tracking Information) Area

Insert editing and post-recording editing tracking signals are recorded here.

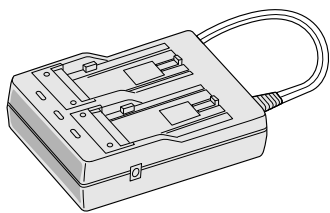

**AC Power  
Adapter/Charger AA-V90EK**

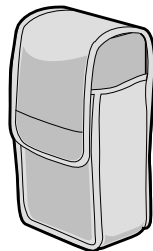

**Soft camera case**

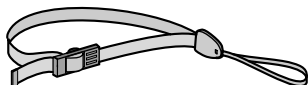

**Hand strap**

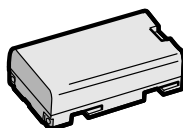

**Battery pack BN-V907U**

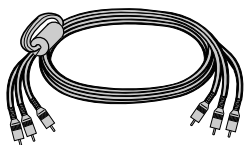

**VIDEO/AUDIO cable  
(Docking Station to TV or VCR,  
RCA plug ▶ RCA plug)**

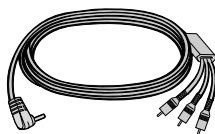

**VIDEO/AUDIO cable  
(camcorder to TV or VCR,  
ø 3.5 mini-plug ▶ RCA plug)**

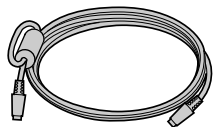

**S-VIDEO cable**

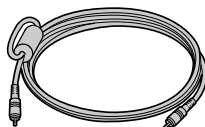

**Editing cable  
(ø 3.5 mini-plug, 2 poles)**

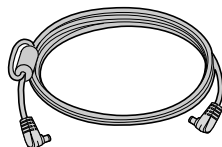

**DC cord**

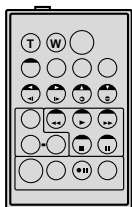

**Remote control unit  
RM-V711U**

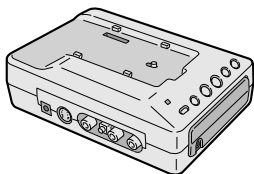

**JLIP Video Capture Docking Station GV-DS2 (referred to in the manual as "Docking Station")**

Use of the JLIP Video Capture Docking Station enables you to capture video images from video sources such as camcorders and VCRs. Also refer to the JLIP Video Capture Docking Station's instruction manual.

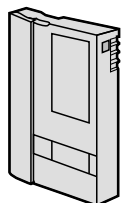

**MiniDV Cassette Tape 30 min  
(DVM-30) M-DV30ME**

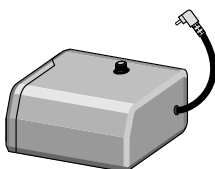

**Power Pack  
CU-V900U**

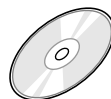

**CD-ROM**  
The CD ROM contains the following 2 software programs:

- JLIP Video Capture
- JLIP Video Producer

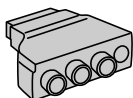

**Cable adapter**



**Lithium battery CR2025  
(for remote control unit)**

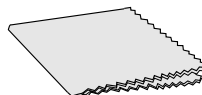

**Cleaning cloth**

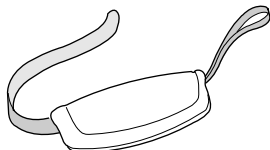

**Grip strap**

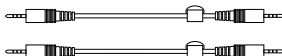

**JLIP connection cables x 2  
(ø 3.5 mini-plug, 4 poles)**

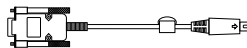

**PC connection cable,  
D-SUB 9-pin**

## Charging The Battery Pack

You can charge one battery pack at a time, or two consecutively.

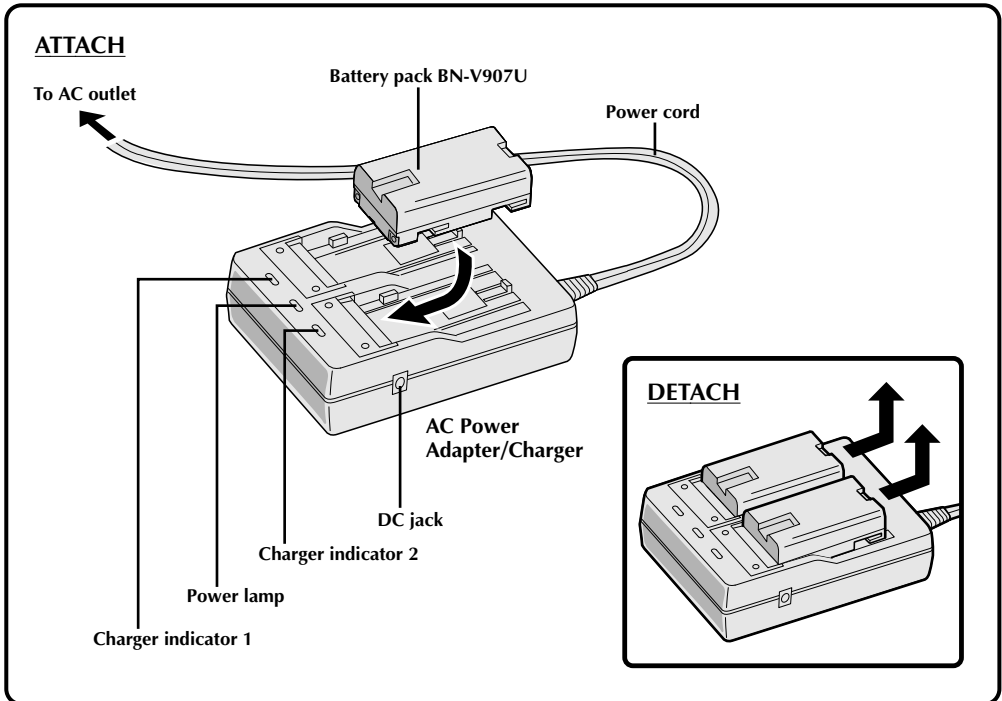

### 1 SUPPLY POWER TO CHARGER

Plug the AC Adapter/Charger's power cord in to an AC outlet. The power lamp comes on.

### 2 ATTACH BATTERY/BATTERIES

Remove the battery pack's protective cap and attach while making sure the  $\oplus$   $\ominus$  marks are facing down and aligned with the corresponding marks on the AC Power Adapter/Charger.

- The Charger Indicator (1 or 2) begins blinking to indicate charging has started.

### 3 CONFIRM STATUS

When the charger indicator stops blinking but stays lit, charging is finished.

- If two batteries are attached to the charger, they will be charged in the order that they were attached.

### 4 DETACH BATTERY/BATTERIES

Slide the battery or batteries in the direction of the arrow and lift off.

- Remember to unplug the AC Adapter/Charger's power cord from an AC outlet.

#### CHARGING TIME\*\*

BATTERY	ONE	TWO
BN-V907U	approx. 100 min.	approx. 200 min.



## NOTES:

- If you connect the camcorder's DC cord to the adapter during battery charging, power is supplied to the camcorder and charging stops.
- When using the AC Power Adapter/Charger, be sure to use the supplied power cord only.
- The AC Power Adapter/Charger is for use with the BN-V907U Battery Pack only.
- When charging the Battery Pack for the first time or after a long storage period, the Charger Indicator may not light. In this case, remove the Battery Pack from the AC Power Adapter/Charger, then try charging again.
- Since the AC Power Adapter/Charger processes electricity internally, it becomes warm during use. Be sure to use it only in well-ventilated areas.
- If the battery operation time remains extremely short even after having been fully charged, the battery is worn out and needs to be replaced. Please purchase a new one.

## \*\* Charging Environment

Perform charging where the temperature is between 10° and 30°C. (20°–25°C is the ideal temperature range for charging.) If the environment is too cold, charging may be incomplete.

## Continuous Shooting

Continuous shooting is possible (See table below for recording time) under the following conditions:

- A BN-V907U Battery Pack is in use
- The temperature is approximately 20°C/68°F

However, . . .

- If the temperature is below 10°C/50°F, or
- If zoom or Record-Standby are engaged or LCD monitor is used repeatedly, continuous shooting capability is reduced significantly. Before extended use, it is recommended that you prepare enough battery packs to cover 3 times the planned shooting time.

## Installing The Battery Pack

The battery pack does not charge while in the camcorder. Before installation, make sure the battery pack has been charged fully.

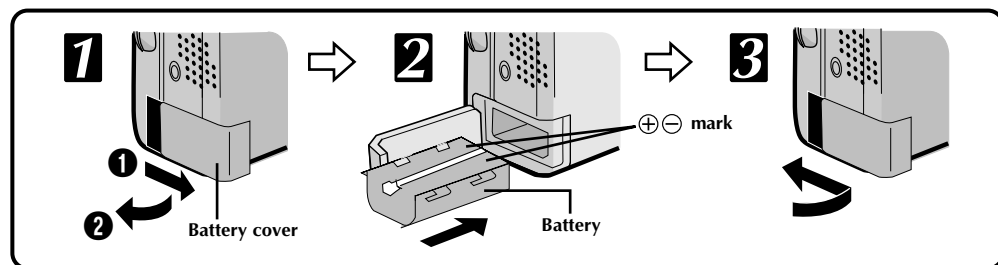

### 1 OPEN BATTERY COVER

- 1 Slide the battery cover.
- 2 Pull open the battery cover in the direction of the arrow.

### 2 INSERT BATTERY

Insert the ⊕ ⊖ mark end of the battery first.

### 3 CLOSE BATTERY COVER

Close the battery cover while pulling it and slide it in the direction of the arrow.

## RECORDING TIME

BATTERY	LCD monitor off/ Viewfinder on	LCD monitor on/ Viewfinder off
BN-V907U	approx. 45 min.	approx. 40 min.

## NOTES:

- To remove the battery pack, turn off the camcorder, open the battery cover and slide the battery pack out.
- Be careful not to drop the battery pack.

## Indoor Use

When using the camcorder indoors, you can use the AC Adapter instead of a battery.

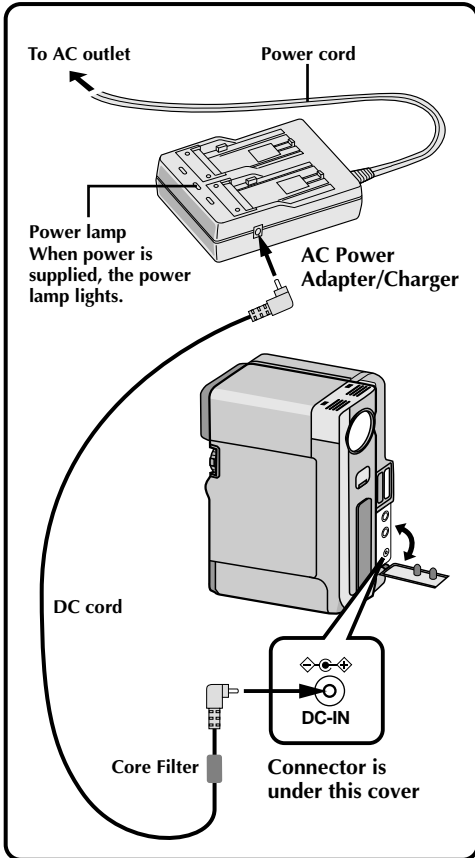

### 1 SUPPLY POWER TO ADAPTER

Plug the AC Adapter/Charger's power cord in to an AC outlet.

### 2 SUPPLY POWER TO CAMCORDER

Connect the AC Adapter to the camcorder.

### NOTE:

When using the provided DC cord, make sure you connect the end of the cable with the core filter to the camcorder. The core filter improves performance of equipment.

## Using The Power Pack

For extended use, prepare the Power Pack, which can be loaded with two battery packs.

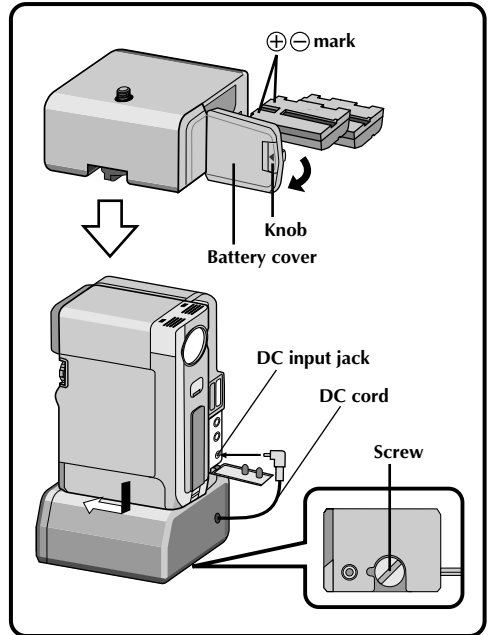

### 1 INSERT BATTERY

Open the battery cover while pressing the knob and insert the ⊕ ⊖ end of the battery first. Close the battery cover.

### 2 ATTACH TO CAMCORDER

Attach the camcorder to the Power Pack in the direction of the arrow. Turn the spring-loaded screw inward and turn it clockwise to attach.

### 3 SUPPLY POWER

Connect the Power Pack DC cord to the camcorder DC input jack.

### NOTES:

- When the battery remaining power indicator appears as , that means the battery power is close to nil. When the battery power is exhausted, power turns off automatically.
- When using the Power Pack, the battery pack installed in the camcorder does not supply power.
- After the battery packs in the Power Pack are exhausted, the battery pack in the camcorder does not begin to supply power. Detach the Power Pack and turn off the camcorder to use the battery pack installed in the camcorder.

## Date/Time Settings

Date and time will automatically be recorded on tape at all times. It is your choice to display it or not during playback (▶ pg. 52).

To set date and time follow the instructions from 1 to 5.

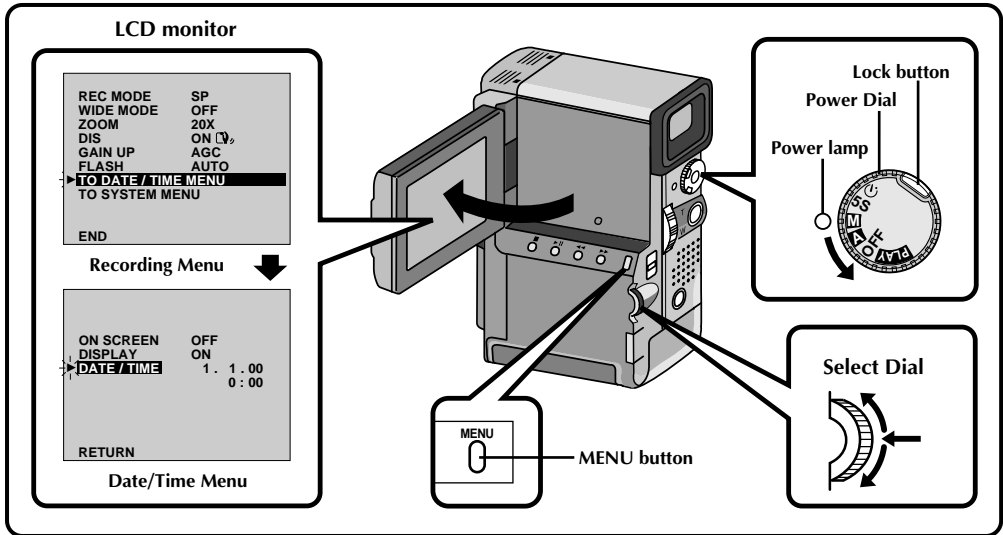

### 1 SELECT OPERATION MODE

Set the Power Dial to “M” while pressing down the lock button located on the dial, and open the LCD monitor fully.

- The power lamp comes on and the camcorder is turned on.
- The LCD monitor can be tilted upward up to 180 degrees and downward up to 90 degrees.

### 2 ACCESS RECORDING MENU

Press MENU. The Recording Menu appears.

### 3 ACCESS DATE/TIME MENU

Move the pointer and highlight bar to “TO DATE/TIME MENU” by rotating the Select Dial. Press the Select Dial and the Date/Time Menu appears.

### 4 INPUT DATE AND TIME

Move the pointer and highlight bar to “DATE/TIME” by rotating the Select Dial. Press the Select Dial and “day” is highlighted and begins blinking.

Rotating the Select Dial (rotate it upward to increase and downward to decrease), input the day. Press the Select Dial. Repeat the procedure to input the month, year, hour and minute.

- Press the Select Dial twice when the pointer and highlight bar are set to “RETURN” to exit.

### Regarding Built-in Rechargeable Battery

To store the date/time in memory, a rechargeable clock lithium battery is integrated in the camcorder. While the camcorder is connected to an AC outlet using the AC Power Adapter/Charger, or while the battery pack installed in the camcorder continues to supply power to the camcorder, the clock lithium battery is always charged. However, if the camcorder is not used for approx. 3 months, the clock lithium battery will become discharged and the date/time stored in memory will be lost. When this occurs, first connect the camcorder to an AC outlet using the AC Power Adapter/Charger etc. for over 24 hours to charge the clock lithium battery. Then perform the date/time setting before using the camcorder.

It is also possible to use the camcorder without the date/time setting.

### NOTE:

*If you don't exit the Date/Time Menu, the clock display will not move but the camcorder's internal clock continues to operate. Once you close the menu, the date and time begin operation from the current date and time, with no delay or loss.*

## Loading/Unloading A Cassette

The camcorder needs to be powered up to load or eject a cassette.

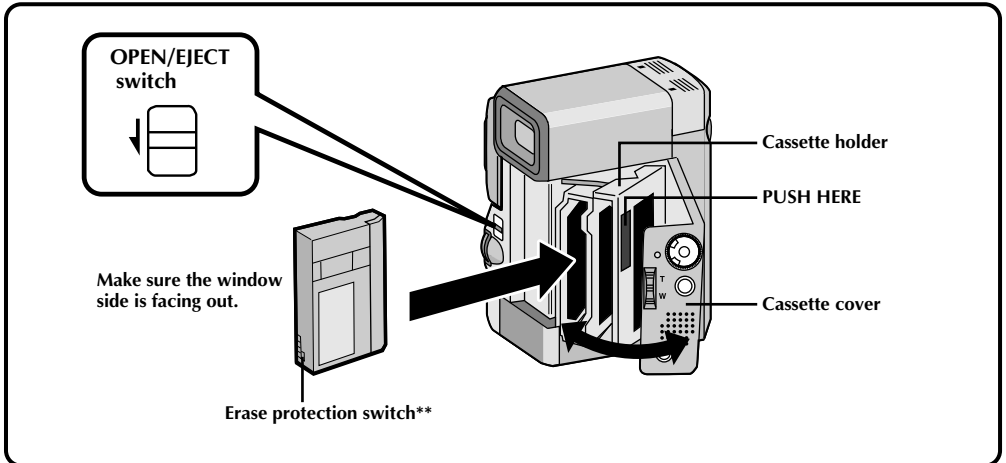

### 1 OPEN CASSETTE COVER

Turn on the power, then slide the **OPEN/EJECT** switch in the direction of the arrow. The cassette cover releases. Open the cover in the direction of the arrow until it locks. The holder opens automatically.

- Do not touch internal components.

### 2 INSERT/REMOVE TAPE

Insert or remove a tape and press "PUSH HERE" to close the cassette holder.

- Once the cassette holder is closed, it recedes automatically. Wait until it recedes completely before closing the cassette cover.
- When the battery's charge is low, you may not be able to close the cover. Do not apply force. Replace the battery with a fully charged one before continuing.

### RECORDING TIME

TAPE	RECORDING MODE	
	SP	LP
DVM-30	Approx. 30 min.	Approx. 45 min.
DVM-60	Approx. 60 min.	Approx. 90 min.

### NOTES:

- It takes a few seconds for the cassette holder to open. Do not apply force.
- If you wait a few seconds and the cassette holder does not open, close the cassette cover and try again.
- Be careful not to get your fingers caught in the holder when it's closing. If this happens, the holder will open automatically after a few seconds.
- When the camcorder is suddenly moved from a cold place to a warm environment, wait a short time before opening the cover.
- Closing the cassette cover before the cassette holder comes out may cause damage to the camcorder.
- When shooting again after already shooting a scene, a blank portion is recorded on the tape or a previously recorded scene is erased (recorded over) if you open the cassette cover, regardless of whether the cassette holder comes out or not. See page 20 for information about recording from the middle of a tape.

### \*\* To protect valuable recordings . . .

.... slide the erase protection switch on the back of the tape in the direction of "SAVE". This prevents this tape from being recorded over. If you decide later that you do want to record on this tape, slide the switch back to "REC" before loading the tape.

## Recording Mode Setting

Set depending on your preference.

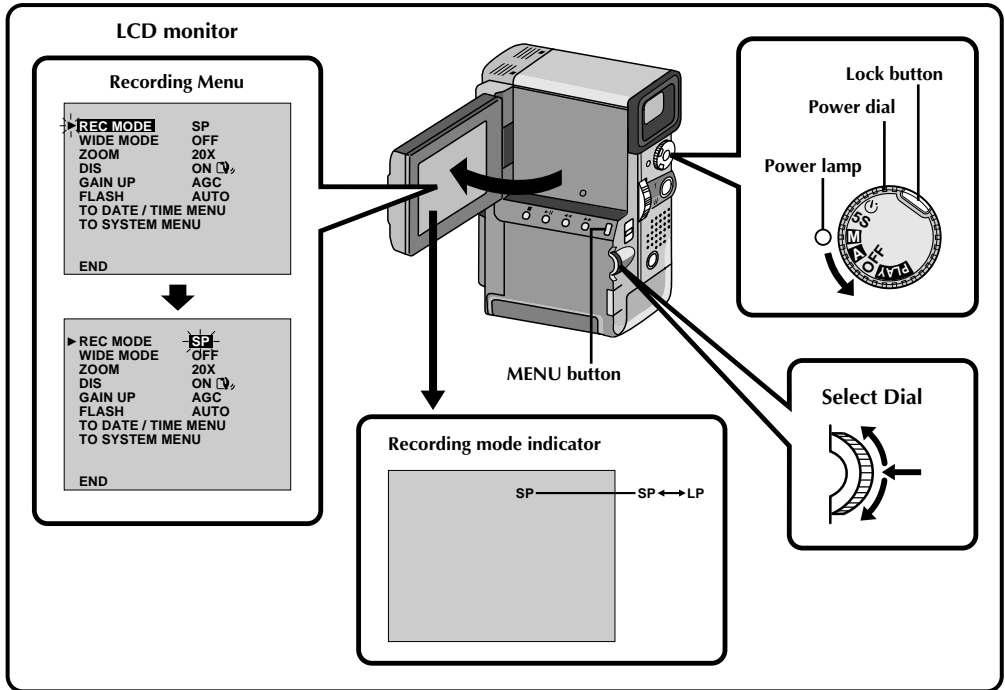

### 1 SELECT OPERATION MODE

Set the Power Dial to "M" while pressing down the lock button located on the dial.

### 2 OPEN LCD MONITOR

Open the LCD monitor fully.

The power lamp comes on and the camcorder is turned on.

- The LCD monitor turns on/off automatically when it is opened/closed at approx. 90 degrees while the Power Dial is set to any operation mode (except "OFF").
- The LCD monitor can be tilted upward up to 180 degrees and downward up to 90 degrees.

### 3 ACCESS RECORDING MENU

Press MENU. The Recording Menu appears.

### 4 SET RECORDING MODE

First move the pointer and highlight bar to "REC MODE" by rotating the Select Dial. Press the Select Dial and the parameter "SP" or "LP" is highlighted. Select "SP" or "LP" by rotating the Select Dial. Press the Select Dial to exit from the Recording Menu.

- Insert Editing or Audio Dubbing is impossible on a tape recorded in the LP mode.
- "LP" (Long Play) is more economical, providing 1.5 times the recording time.

### NOTES:

- If the recording mode is switched during recording, the playback picture will be blurred at the switching point.
- It is recommended that tapes recorded in the LP mode on this camcorder be played back on this camcorder.
- During playback of a tape recorded on another camcorder, blocks of noise may appear or there may be momentary pauses in the sound.

## Hand Strap Attachment

The provided Hand Strap helps you to keep a firm hold on the camcorder. Make sure you never hold the camcorder without using the Hand Strap.

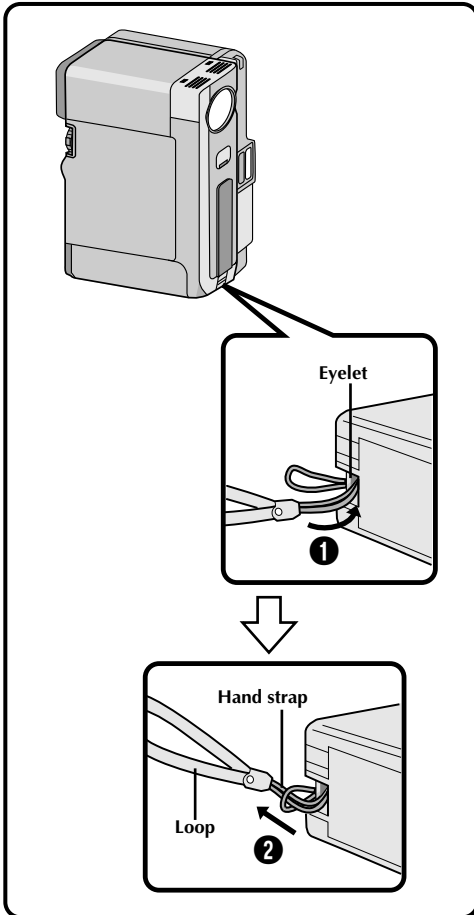

### 1 ATTACH HAND STRAP

Thread the strap through the eyelet **1**, then thread the loop through the end of the strap **2**. Pull firmly to ensure secure attachment.

## Using The Soft Camera Case

Keep the camcorder in the soft camera case when transporting it.

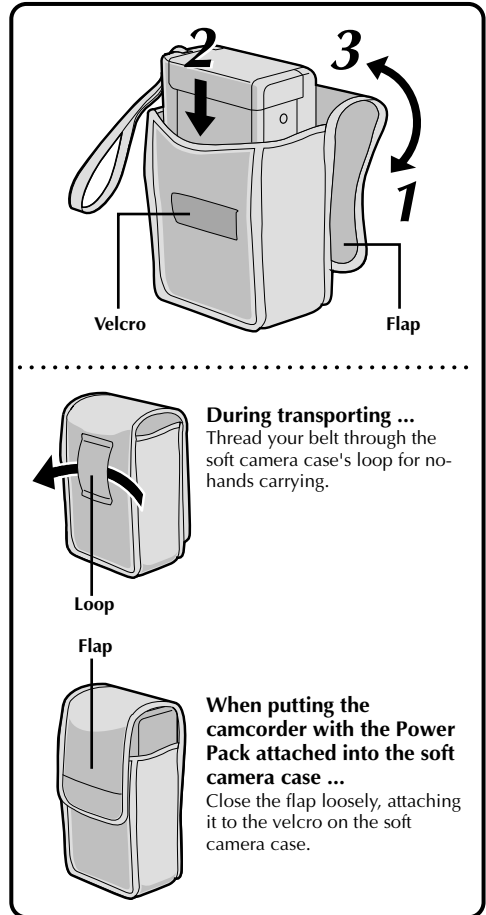

### During transporting ...

Thread your belt through the soft camera case's loop for no-hands carrying.

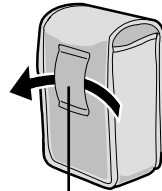

### When putting the camcorder with the Power Pack attached into the soft camera case ...

Close the flap loosely, attaching it to the velcro on the soft camera case.

### 1 OPEN FLAP

### 2 PUT CAMCORDER IN

Insert with lens side down. By doing this, you can begin shooting as soon as you take out the camcorder from the soft camera case.

### 3 CLOSE FLAP

## Grip Strap Attachment

Before attaching the grip strap, detach the hand strap from the camcorder (☞ pg. 14).

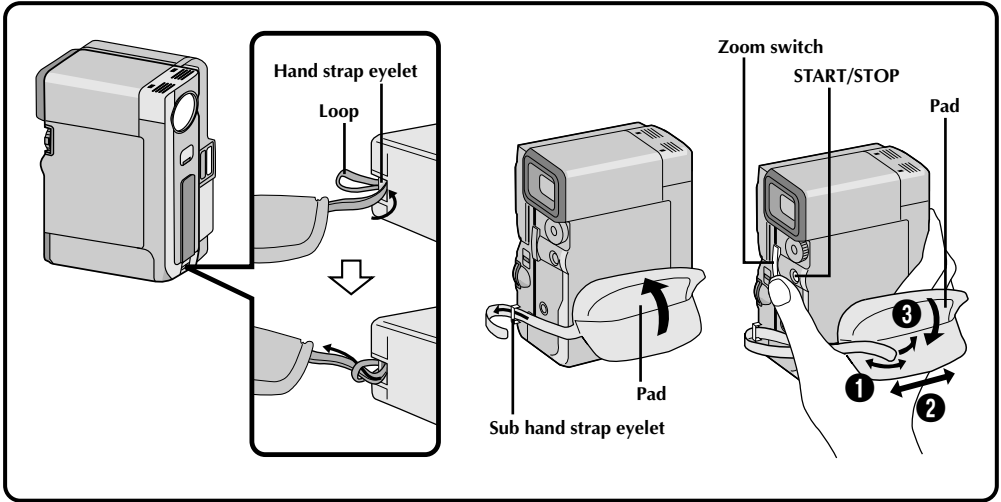

### 1 ATTACH GRIP STRAP TO HAND STRAP EYELET

Thread the end of the grip strap through the hand strap eyelet, then thread the other end of the grip through the loop. Pull firmly to ensure secure attachment.

### 2 ATTACH GRIP STRAP TO SUB HAND STRAP EYELET

Open the pad and thread the end of the grip strap through the sub hand strap eyelet.

### 3 ADJUST LENGTH

Adjust so your thumb and fingers can easily operate the **START/STOP** button and the zoom switch ①. Position the pad so that it contacts the back of your hand ②, then re-attach it ③.

#### NOTE:

If you want to take a snapshot (☞ pg. 25) while grasping the camcorder through the Grip strap attached to the hand strap eyelet and the sub hand strap eyelet, press the **Sub SNAPSHOT** button (▶▶) using your left hand. Because the **SNAPSHOT** button will be covered by your right hand, pressing it will not be possible.

## Tripod Mounting

Align the tripod's screw with the mounting socket on the bottom of the camcorder. The camcorder can be mounted on a tripod even with the Power Pack attached.

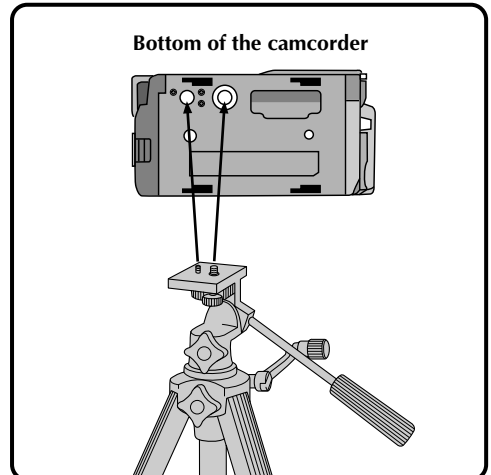

## Dioptre Adjustment

Adjust the viewfinder display for best viewing.

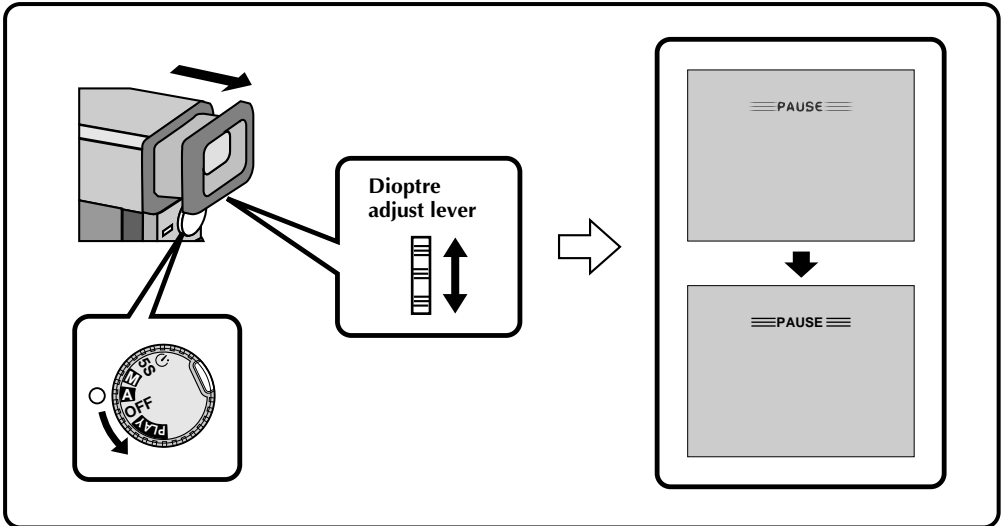

**1 SELECT OPERATION MODE**  
Set the Power Dial to "A", or "M".

**2 TURN ON CAMCORDER**  
Pull out the viewfinder fully.

**3 ADJUST DIOPTR**  
Slide the Dioptre Adjust Lever located on the bottom of the viewfinder.

- Slide in either direction, while looking at the viewfinder display, until it looks best to you.



## Remote Control Unit

You can use the RM-V711U to control the camcorder. When using the remote control, be sure to point it at the remote sensor. The transmitted beam effective area for indoor use is approx. 5 m. The transmitted beam may not be effective or may cause incorrect operation if the remote sensor is directly exposed to sunlight or powerful lighting.

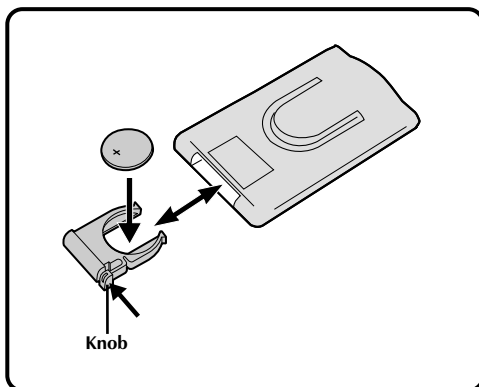
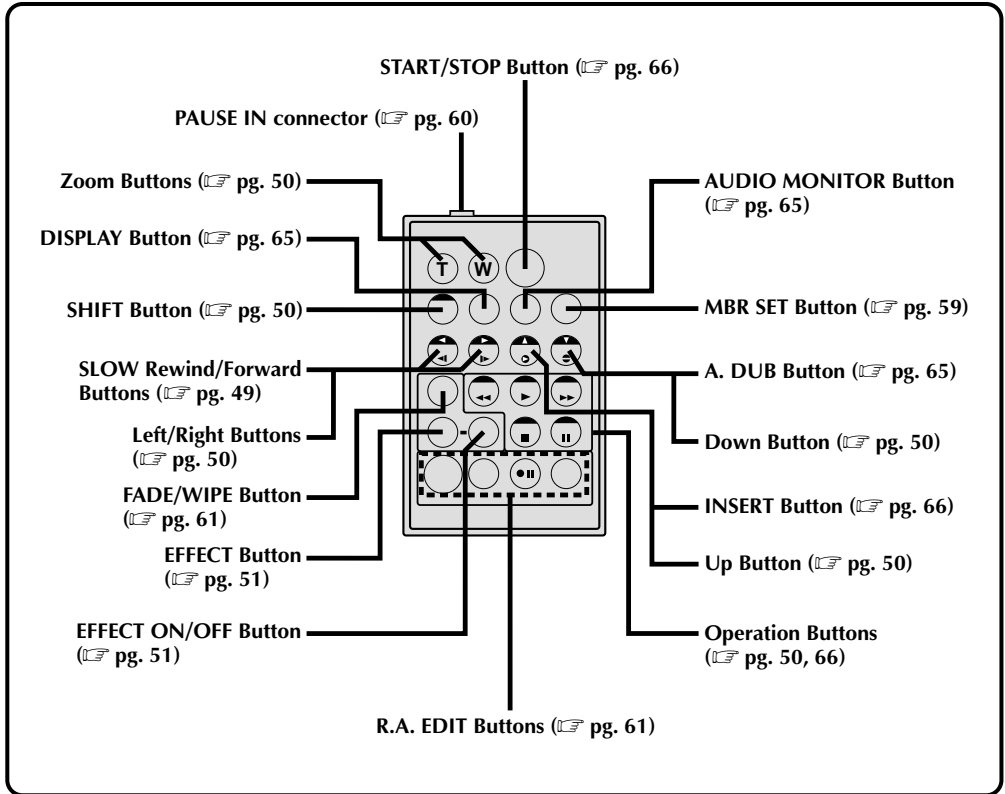

## Installing The Battery

The RM-V711U uses one lithium battery (CR2025).

### 1 PULL OUT BATTERY HOLDER

Pull out in the direction of the arrow while pressing the knob as shown.

### 2 INSERT BATTERY IN HOLDER

Insert the battery in the holder, and be sure to have the "+" mark visible.

### 3 RE-INSERT HOLDER

Slide the holder back in until you hear a click.

- Read the caution concerning lithium batteries (pg. 2).

## Operation Mode

Tuning the Power Dial allows you to choose the appropriate operation mode among the following modes: Full Auto mode (A), Manual mode (M), 5 second mode recording (5S), Self-Timer mode (⌚) and "PLAY".

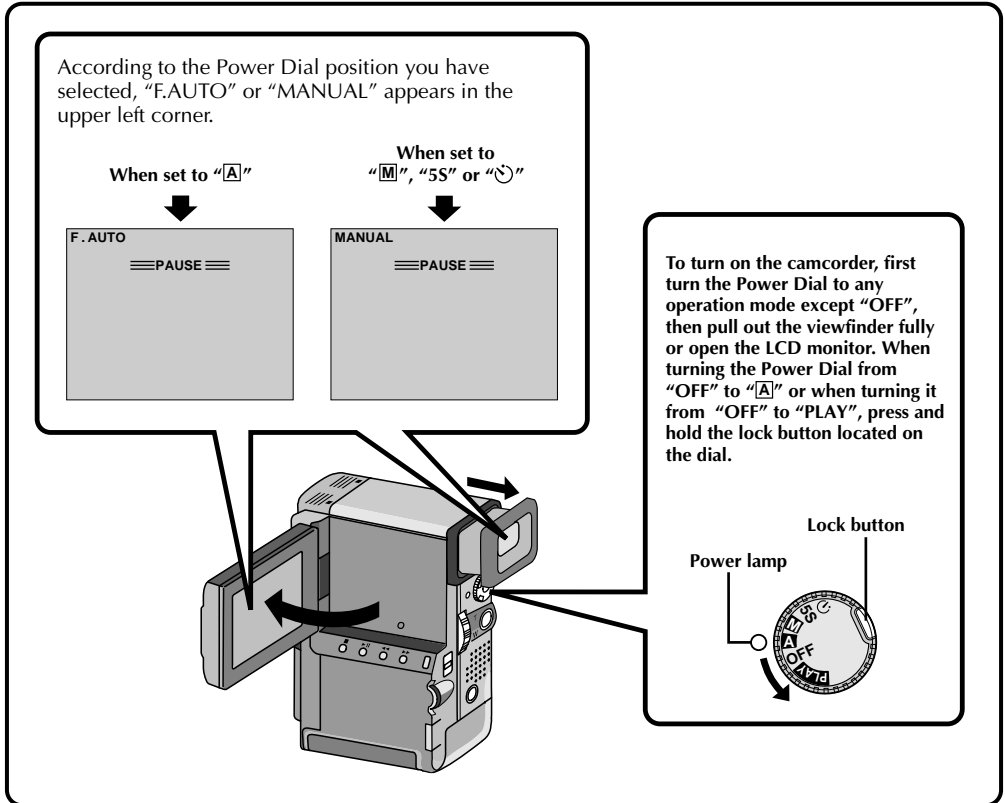

Power Dial Position	Function
Full Auto: A	Allows you to record using NO special effects or manual adjustments. Suitable for standard recording.
Manual: M	Allows you to set various recording functions using the Menus. If you want more creative capabilities than Full Auto recording, try this mode.
5 second mode recording: 5S	Allows you to record in 5-second clips to keep the action moving. Other menu settings are the same as Full Auto mode, however manually adjusted White Balance Adjustment settings are effective.
Self-Timer: ⌚	Allows you (camcorder operator) to become part of the scene once the camcorder is set. This mode is similar to the Self-Timer on film cameras.
Playback: PLAY	Allows you to play back a recording.  pg. 49 – 57.

## Basic Recording

You should already have performed the necessary preparations (☞ pgs. 8 – 16). Set the Power Dial to “A” and try recording that way before attempting to use more advanced features.

### NOTE:

Before starting recording, make sure you set the date and time (☞ pg. 11). Even if they don't appear during recording, you can display them during playback (☞ pg. 53).

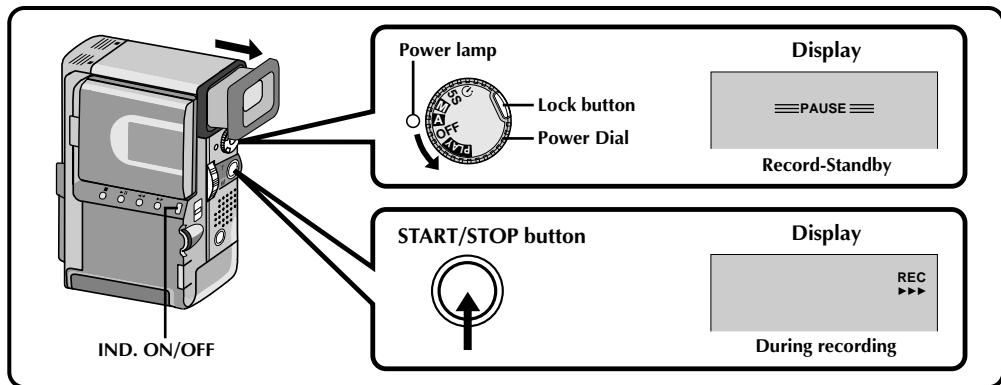

### 1 SELECT OPERATION MODE

Set the Power Dial to “A” while pressing down the lock button located on the dial.

### 2 PULL OUT VIEWFINDER OR OPEN LCD MONITOR

Pull out the viewfinder fully or open the LCD monitor to approx. 90° degrees.

- The lens cover opens, the power lamp comes on and the scene you're aimed at appears.
- The Record-Standby mode is engaged.

### 3 START RECORDING

When “PAUSE” appears, press **START/STOP**. A beep signals the start of recording.

### 4 STOP RECORDING

Press **START/STOP** again to stop recording.

- The camcorder re-enters Record-Standby mode.

### 5 END RECORDING

When you're finished recording, push back the viewfinder or close the LCD monitor until it clicks; the lens cover closes and the power lamp goes out.

- When transporting, make sure the viewfinder is pushed back and the LCD monitor is closed and locked.
- To turn power on again, pull out the viewfinder or open the LCD monitor.

### OR

Set the Power Dial to “OFF”.

- When turning to “OFF”, it is not necessary to press down the lock button.

### NOTES:

- The image will not appear simultaneously in the LCD monitor and the viewfinder. No image appears on the LCD monitor when the viewfinder is pulled out. It is not possible to shoot using both LCD monitor and viewfinder.
- If 5 minutes elapse in the Record-Standby mode, power shuts off automatically to conserve energy and protect the heads. To turn the camcorder on again, push back and pull out the viewfinder again or close and re-open the LCD monitor. As long as you don't take out the tape you were using or play it back, you can continue from where you left off with no noticeable break on the recorded video.
- When a blank portion is left between recorded scenes on the tape, the time code is interrupted and errors may occur when editing the tape. Continue recording from where you stop so there are no gaps by following “Recording from the middle of a tape” (☞ pg. 20).
- Recored-Standby means that a tape is loaded and the camcorder is ready to record.
- During recording, sound is not heard from the speaker. If you want to hear the sound, connect optional headphones to the headphones jack. The sound volume at this point is the same as the level it was adjusted during playback.
- To make the indications disappear, press and hold the **IND.ON/OFF** button for more than approx. 1 second. However, it is impossible to remove the tape running indicator “▶▶▶” and warning indications and so on (☞ pg. 76).
- Use the viewfinder when under direct sunlight or when reflections make it difficult to see the LCD monitor.

## Recording From The Middle Of A Tape

When removing a tape on which you were recording, or when you resume recording on a tape after playing back the recording previously made (without taking the tape out between recordings), perform this procedure.

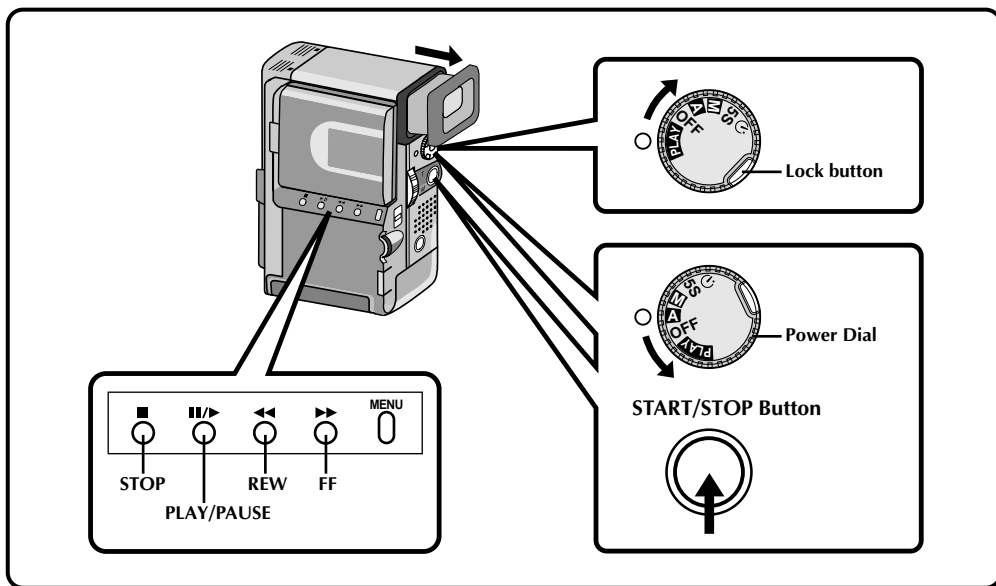

### 1 SELECT OPERATION MODE

Turn the Power Dial to "PLAY" while pressing down the lock button located on the dial.

### 2 PULL OUT VIEWFINDER OR OPEN LCD MONITOR

Pull out the viewfinder fully or open the LCD monitor to approx. 90° degrees.

- The lens cover opens, the power lamp comes on.

### 3 START SEARCH

Press ►/II, then press ◀◀ or ▶▶. Watch in the viewfinder or the LCD monitor for the spot where you want to begin recording.

### 4 ENGAGE STILL MODE

Once you find the spot at which you want to start recording, press ►/II to engage the Still mode.

### 5 START RECORDING

Turn the Power Dial to any operation mode except "PLAY" and "OFF", then press **START/STOP**.

- Start recording from a point prior to the end of the last recording. A few seconds of the end of the last recording will be erased.

### NOTE:

*If you start recording from the end of the previous recording leaving no blank space, there may be situations where a clean transition is not possible.*

## Time Code

During recording, a time code is recorded on the tape. This code is to confirm the location of the recorded scene on the tape during playback.

If recording starts from a blank portion, the time code begins counting from "00:00:00" (minute:second:frame). If recording starts from the end of a previously recorded scene, the time code continues from the last time code number.

To perform Random Assemble Editing (☞ pg. 60), time code is necessary. If during recording a blank portion is recorded partway through the tape, the time code is interrupted. When recording is resumed, the time code starts counting up again from "00:00:00". This means the camcorder may record the same time codes as those existing in a previously recorded scene. To prevent leaving a blank portion on a tape, perform the procedure in "Recording From The Middle of A Tape" (☞ pg. 20) in the following cases;

- After playing back the recorded tape, when you shoot again.
- When power shuts off during shooting.
- When a tape is removed and re-inserted during shooting.
- When shooting using a partially recorded tape.
- When shooting on a blank portion located partway through the tape.
- When shooting again after already shooting a scene and opening/closing the cassette cover.

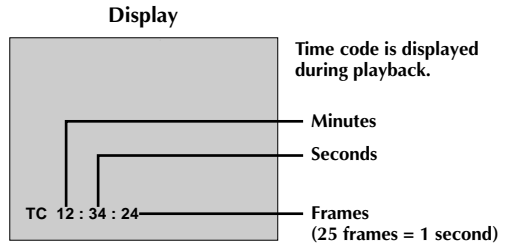

## NOTES:

- The Time Code cannot be reset.
- During fast-forwarding and rewinding, time code indication does not move smoothly.

### When blank portion is recorded on a tape

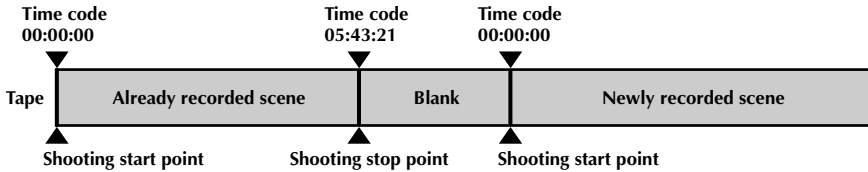

### Proper recording

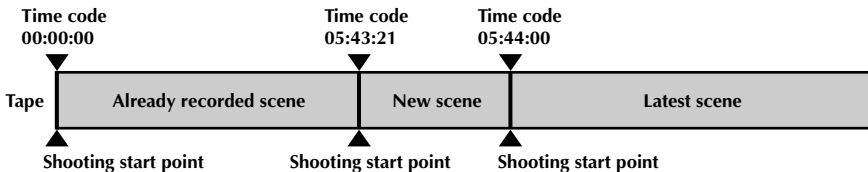

## Tape Remaining Indicator

The time remaining on the tape is automatically monitored and displayed (☞ pg. 76). When the tape ends, "TAPE END" appears. If the indications are turned off, the tape remaining indicator appears when remaining time reaches 2 minutes.

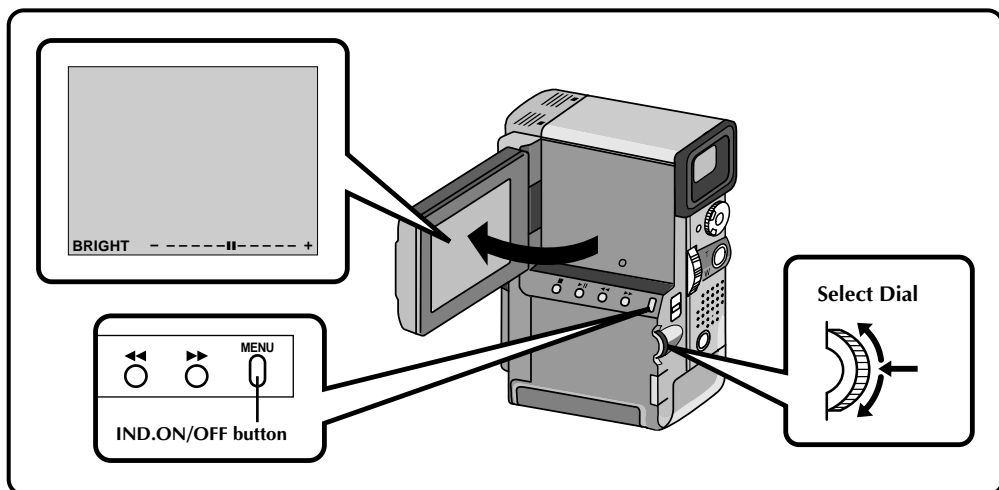
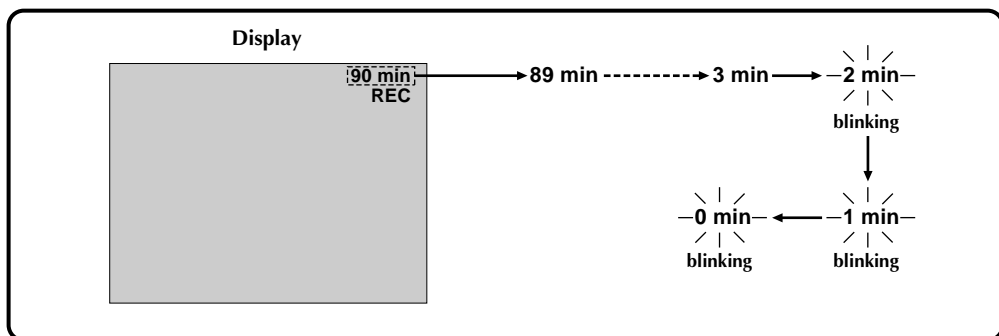

## Brightness Control

You can adjust the brightness of the LCD monitor by rotating the Select Dial.

### 1 ADJUST BRIGHTNESS

*If you want to brighten the image...*

Rotate the Select Dial upward until the brightness indicator moves and the LCD monitor reaches its appropriate brightness.

*If you want to darken the image...*

Rotate the Select Dial downward until the brightness indicator moves and the LCD monitor reaches its appropriate brightness.

- The brightness indication appears in the LCD monitor.

## LCD Monitor/Viewfinder Indications

You can make the LCD monitor/Viewfinder indications appear/disappear.

### 1 PRESS IND.ON/OFF BUTTON

When you do not want the indications to appear, press the **IND.ON/OFF** button for longer than approximately 1 second. Certain indications disappear.

Press again for longer than approx. 1 second to make the indications reappear.

### NOTE:

*It is impossible to make the tape running indicator and warnings etc. disappear from the LCD monitor or the viewfinder. For the indications that can be removed, ☞ pg.76*

## Journalistic shooting

In some situations different angles of shooting may be required for more dramatic results.

### 1 OPEN LCD MONITOR

Make sure the viewfinder is pushed back and the LCD monitor is fully open (approx. 90°).

### 2 TILT LCD MONITOR

Tilt the LCD monitor in the most convenient direction.

- The LCD monitor can rotate almost full circle (270°: 90° downward, 180° upward).

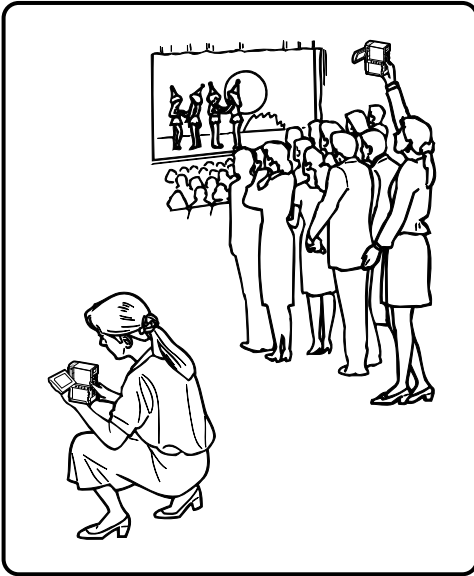

## Interface Shooting

You can shoot yourself while viewing your own image in the LCD monitor.

### 1 TILT LCD MONITOR UPWARD





Open the LCD monitor and tilt it upward to 180 degrees so that it faces forward.

### 2 START RECORDING

Point the lens towards yourself and start recording.

- During Interface Shooting, the “Tape Running” indicator and warning indications (see pg. 78) are the only ones that will be shown; they will appear horizontally reversed in the display, but are not reversed in the recording.

## NOTE:

The tape remaining indicator does not appear during interface shooting. However, when the remaining time reaches 2 minutes, the indicator appears showing the remaining time:  -  (blinking)  (blinking)  (blinking)

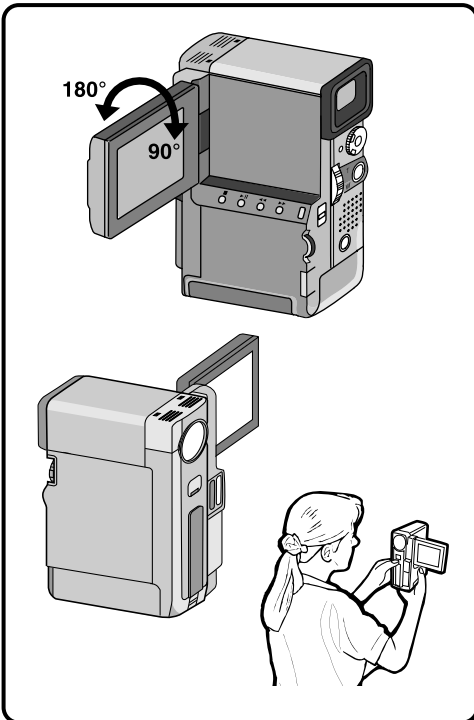

## Zoom

Select any one of the three powers of magnification and get “closer” to the subject (☞ pg. 32).

Simply set the zoom switch to either zoom in (towards “T”) or zoom out (towards “W”). The zoom speed is variable — the quicker you set the zoom switch, the quicker the zoom action.

### NOTES:

- Zoom magnification of over 10X is done through Digital image processing, and is therefore called Digital Zoom.
- During Digital Zoom, the quality of image may suffer.
- Digital zoom cannot be used while the Video Echo effect (☞ pg. 43), Snapshot Dissolve (☞ pg. 25), the Picture Wipe/Dissolve function (☞ pg. 38) or the 5SD mode (☞ pg. 28) are activated.
- Macro shooting (as close as approx. 3 cm to the subject) is possible when the zoom switch is set all the way to “W”.

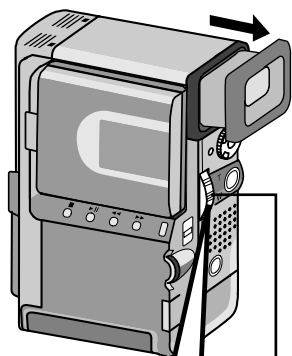

Zoom switch

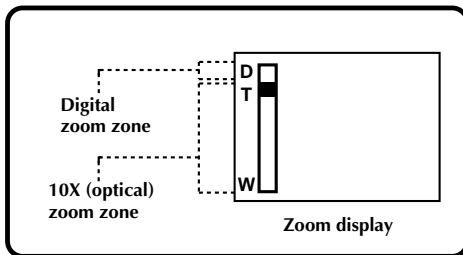

Zoom in (T: Telephoto)

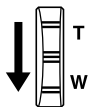
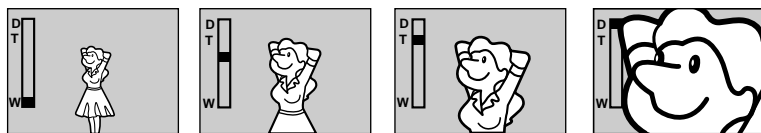

Zoom out (W: Wide angle)





## Snapshot

Use your camcorder like a regular camera and take a snapshot, or several of them in succession.

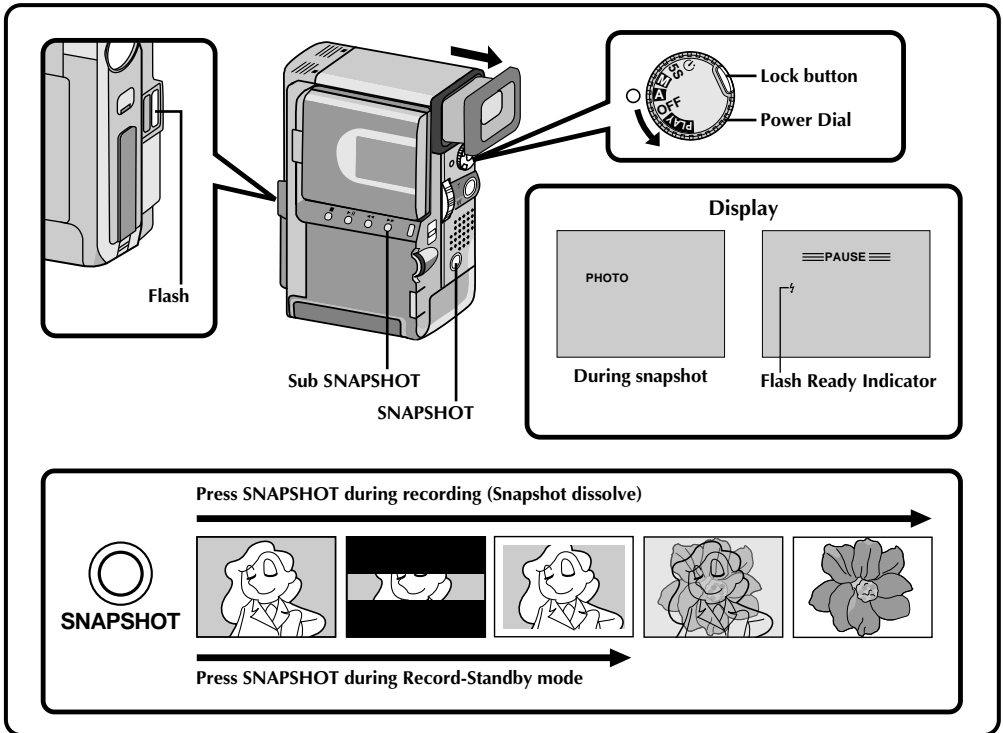

### 1 SELECT OPERATION MODE

First turn the Power Dial to any operation mode except "PLAY" and "OFF", make sure the viewfinder is pulled out or the LCD monitor is open fully.

### 2 TAKE SNAPSHOT

Press SNAPSHOT.

**If you press during Record-Standby...**

.... "PHOTO" appears and a still image will be recorded for approx. 5 seconds, then the camcorder re-enters the Record-Standby mode.

**If you press during Recording...**

.... "PHOTO" appears and a still image will be recorded for approx. 5 seconds. The next image then gradually overlaps the snapshot and normal recording resumes.

- The sound effect of a shutter closing is recorded together with the image.

### Snapshot Flash:

The flash automatically lights at the subject when it's dark (flash ready indicator ⚡ appears in the viewfinder or the LCD monitor) when taking a snapshot in Record-Standby (ⓘ pg. 26)

### Motor Drive mode:

Keeping SNAPSHOT pressed provides an effect similar to serial photography. (The interval between the still pictures: approx. 0.7 seconds.)

### Changing the Snapshot Setting:

- Still image with no frame can also be recorded (ⓘ pg. 34, 35).
- When you don't want to hear the shutter sound, set BEEP/TALLY to "OFF" in the system menu (ⓘ pg. 34, 35). Though the sound is not heard from the speaker, it is recorded on the tape.

### NOTE:

When the grip strap is fastened to both the strap eyelet and the sub-strap eyelet, use the **Sub SNAPSHOT** button to take a snapshot.

## Snapshot Flash (Auto Flash)

During Full Auto mode, or Manual mode when “FLASH” is set to “AUTO” in the Recording Menu, the flash automatically lights at the subject if it's dark (⚡ appears in the LCD monitor or the viewfinder) when taking a snapshot in Record-Standby.

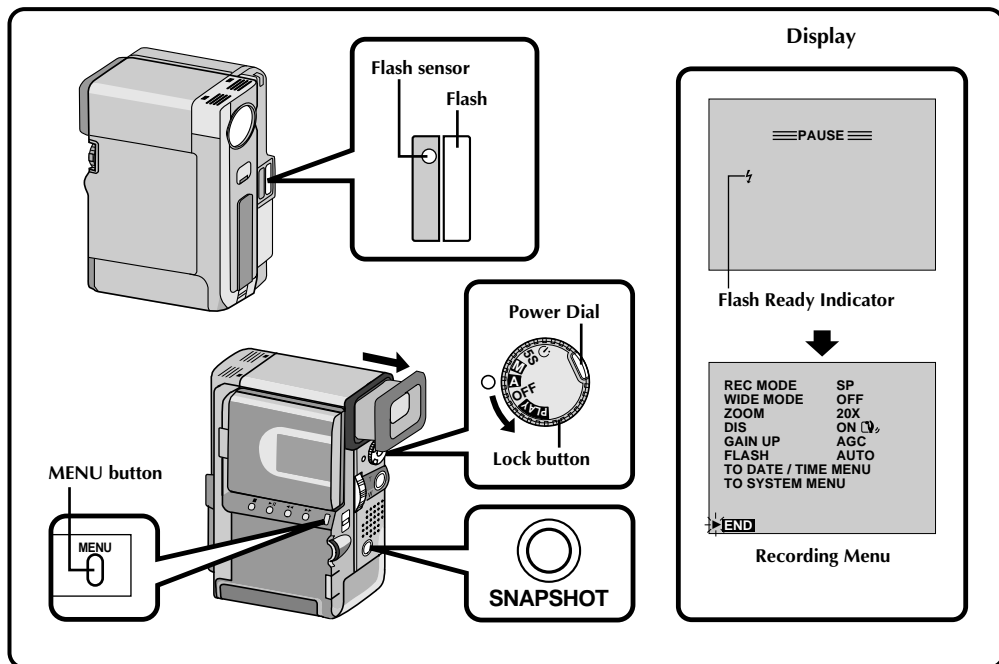

### 1 ENGAGE RECORD-STANDBY

First turn the Power Dial to any operation mode except “PLAY” and “OFF”, make sure the viewfinder is pulled out or the monitor is open fully.

If the power dial is set to “A”... go to step 5.

If the power dial is set to “M”, “5S” or “S”... go to step 2.

### 2 ACCESS RECORDING MENU

Press MENU. The Recording Menu appears.

### 3 SELECT FUNCTION

Rotate the Select Dial to move the pointer and highlight bar to “FLASH”, then press it.

### 4 SELECT FUNCTION PARAMETERS

Rotate the Select Dial to display “AUTO” and press it. Setting is complete.

### 5 TAKE SNAPSHOT

Press SNAPSHOT.

## NOTES:

- The flash does not light when the flash is set to “OFF” on the recording menu when GAIN UP is set to “OFF” (☞ pg. 32), when P.AE effect is set to “TWILIGHT” and also when the battery remaining power is low.
- When taking several snapshots in succession (Motor Drive Mode), the flash lights only during the first one.
- Although images shot with a flash tend to look whiter than they actually are, to compensate for this camcorder automatically darkens the picture when using the flash. When shooting a subject at a distance where the flash light cannot reach (over 2 m), set the flash to “OFF” to prevent the picture from becoming too dark.
- The colour tone changes depending on the background lighting conditions, such as under fluorescent or halogen lamps.
- When you want to change the brightness of the flash, refer to “Adjusting Flash Brightness” (☞ pg. 27).
- While charging the flash, ⚡ blinks in the LCD monitor or the viewfinder and the flash does not light. Although noise may appear in the viewfinder or the LCD monitor, this is not a malfunction. This is not recorded. It can take up to ten seconds to charge the flash.

## Adjusting Flash Brightness

When a snapshot ( pg. 25) is taken in the dark the camcorder flashes ( pg. 26) while adjusting the brightness automatically. You can also adjust the flash brightness manually. When you find that the snapshots you took look too bright or too dark, adjust it manually.

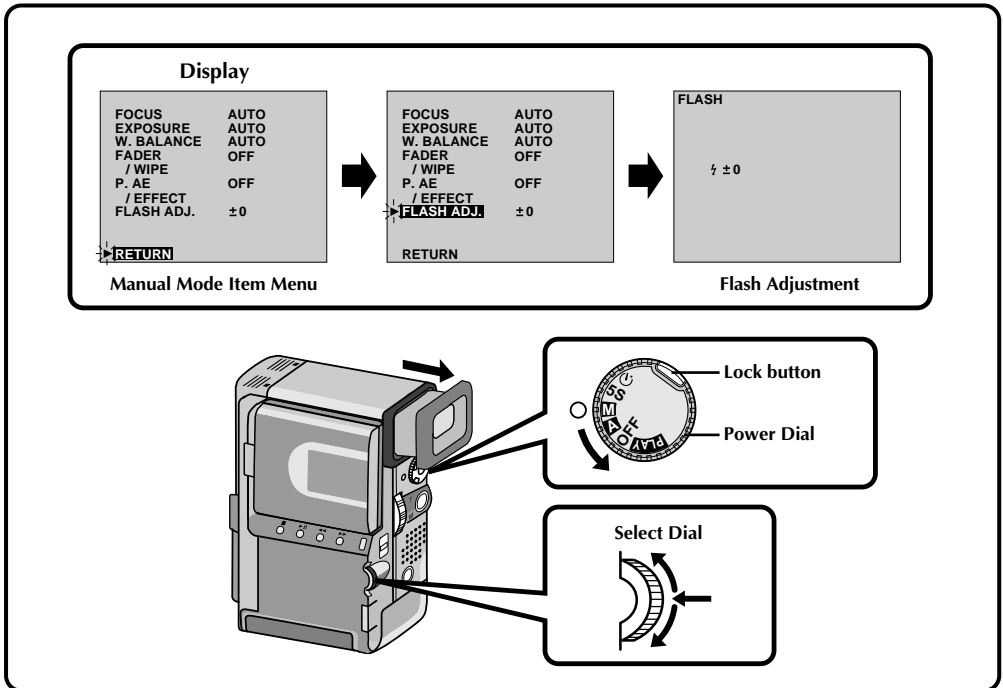

### 1 SELECT MODE

First turn the Power Dial to "M" while pressing down the lock button located on the dial. Make sure the LCD monitor is open fully or the viewfinder is pulled out.

### 2 ACCESS MANUAL MODE ITEM MENU

Press the Select Dial and move the pointer and highlight bar to "FLASH ADJ." by rotating the Select Dial.

### 3 ACCESS FLASH ADJUSTMENT

Press the Select Dial. The Manual Mode Item Menu disappears, "FLASH" appears in the upper left corner and a number appears next to the indication to allow adjustment of the flash manually on the screen.

### 4 ADJUST BRIGHTNESS OF FLASH

Rotating the Select Dial upward increases the number of the brightness adjustment indicator and rotating the Select Dial downward decreases it.

- The adjustment range is from -3 to +3.

### 5 ACTIVATE BRIGHTNESS OF FLASH

Press the Select Dial. The flash brightness adjustment is complete. The indication "FLASH" changes to "MANUAL".

#### NOTES:

- When the battery power is low, the screen to set "FLASH ADJ." sometimes does not appear.
- When you change the subject you are shooting or the shooting location, set it back to ±0 as described in step 4 and take a snapshot to check the flash brightness. After doing this adjust to your desired brightness.
- When FLASH on the Recording menu is set to "OFF" the brightness of the flash cannot be adjusted.
- When GAIN UP is set to "OFF" or Twilight is selected in P.AE Effect, the flash will not light.

## Scene (5-second recording)

Record a vacation or an important event in 5-second clips to keep the action moving. The 5-Second function may also be activated during Full Auto operation. But the White Balance remains in the previously adjusted condition. While the 5-Second mode is activated, Fade/Wipe (☞ pg. 36), P.AE/Effects (☞ pg. 42) and other manual operations cannot be performed.

**Lock button**

**Power Dial**

**START/STOP button**

**Display**

MANUAL REC  
▶▶

5S MODE

↓ After 5 sec.

MANUAL  
≡ PAUSE ≡

5S MODE

Record-Standby

**Dissolves during 5 second mode recording**

Select "5SD" at the System Menu (☞ pg. 34). "5SD MODE" appears in step 2 below. Record one 5-second clip, and the image at the end of the clip is stored. If you record the next clip within 5 minutes, the previous scene dissolves as the new scene appears.

\* If you turn the power off, the stored image will be lost.

### 1 SELECT OPERATION MODE

Turn the Power Dial to "5S" while pressing down the lock button located on the dial.

### 2 PULL OUT VIEWFINDER OR OPEN LCD MONITOR

Pull out the viewfinder fully. "5S MODE" appears.

### 3 ENGAGE 5S MODE

Then press **START/STOP**. The tally lamp lights and beep sounds to indicate the start of recording, and after 5 seconds the camcorder enters Record-Standby mode.

- If you press and hold **START/STOP** within 5 seconds after recording starts, Record-Standby mode is not engaged.

### 4 END 5-SECOND MODE RECORDING

Set the Power Dial to the "A", "M" or "OFF" position.

#### To Take A Snapshot In The 5-Second Mode . . .

.... instead of pressing, **START/STOP** in step 3, press **SNAPSHOT**. The camcorder records a 5-second still with the shutter sound.

(☞ pg. 25). But when the Scene is set to animation (☞ pg. 35) this function is not available.

#### NOTE:

When "SCENE" is set to "ANIM." in the System Menu, the 5-second recording function is not available. Animation recording of a 1/8-second clip is taken instead (☞ pg. 35).

## Self-Timer

Once the camcorder is set, the camcorder operator can become part of the scene in a more natural way adding the final touch to a memorable picture.

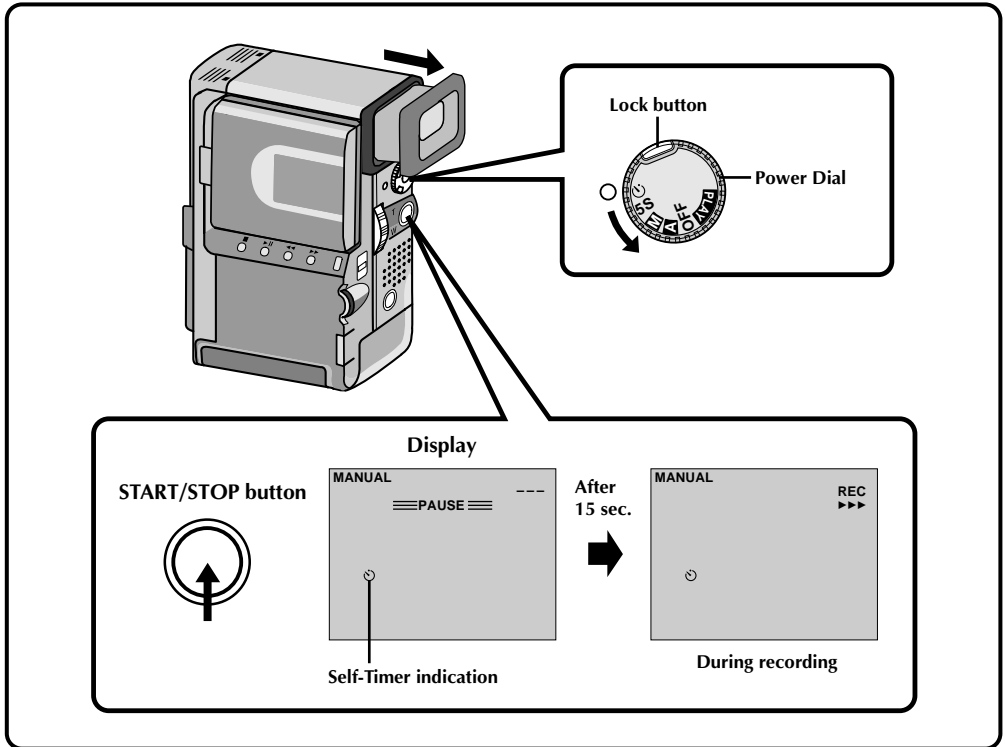

### 1 SELECT OPERATION MODE

Turn the Power Dial to “☺” while pressing down the lock button located on the dial.

### 2 PULL OUT VIEWFINDER OR OPEN LCD MONITOR

Pull out the viewfinder fully.

- The camcorder enters the Record-Standby mode.
- You can tilt the LCD monitor upward to 180 degrees so that it faces forward and view yourself while self-recording (with the viewfinder pushed back).

### 3 ENGAGE SELF-TIMER MODE

Press **START/STOP**. The tally lamp lights and begins blinking. After approx. 15 seconds, the light stops blinking and stays on and recording begins with a beep sound.

### 4 STOP SELF-TIMER RECORDING

Press **START/STOP**.

- The camcorder re-enters Record-Standby mode.

### 5 END SELF-TIMER RECORDING

Set the Power Dial to the “**A**”, “**M**” or “**OFF**” position.

- When turning to “**OFF**”, it is not necessary to press down the lock button.

#### To Take A Snapshot In The Self-Timer Mode . . .

.... in step 3, press **SNAPSHOT** instead of **START/STOP**. After 15 seconds, a 5-second still with the shutter sound effect is recorded. After that, the camcorder enters the Record-Standby mode.

## Menus

The Recording Menu allows you to set these functions:

*Recording Mode, Wide Mode, Zoom Magnification, Digital Image Stabilizer, Gain Up, Flash, Date/Time Menu, System Menu.* The following selection procedure applies to *Recording Mode, Wide Mode, Zoom Magnification, Stabilization, Gain Up and Flash.*

Please refer to page 31, 32 for details.

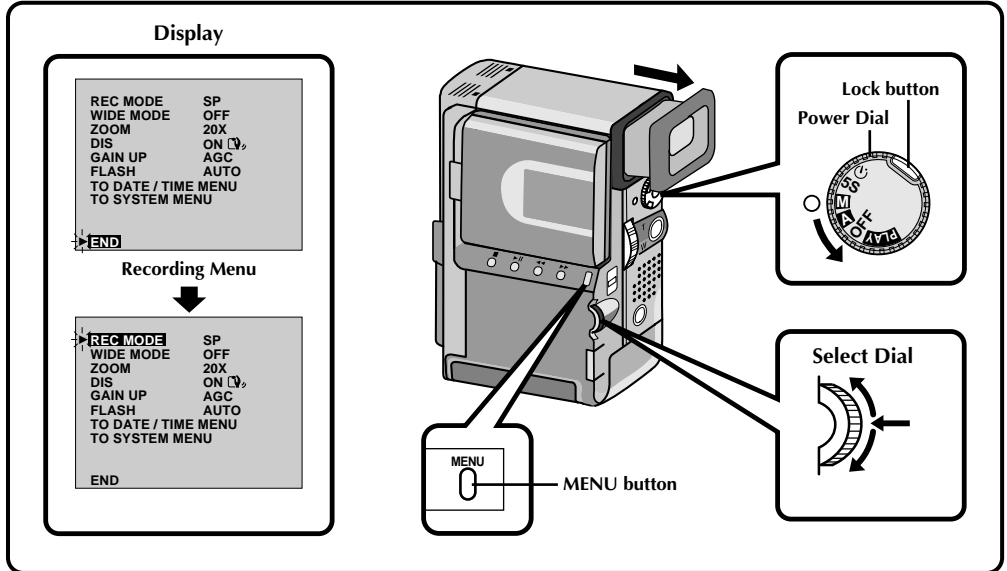

### 1 SELECT OPERATION MODE

First turn the Power Dial to "M" while pressing down the lock button located on the dial, make sure the LCD monitor is open fully or the viewfinder is pulled out.

### 2 ACCESS RECORDING MENU

Press MENU. The Recording Menu appears.

### 3 SELECT FUNCTION

Move the pointer and highlight bar to the desired function by rotating the Select Dial, then press it. The pointer stops blinking, indicating that the function has been selected.

### 4 SET FUNCTION PARAMETERS

Cycle the available settings of the selected function by rotating the Select Dial. Stop when the one you need is displayed. Then press it, the pointer and highlight bar automatically move to "END".

- To set the parameters for a different function, repeat steps 3 and 4.

### 5 CLOSE RECORDING MENU

Press the Select Dial. Selection is complete and the menu disappears.

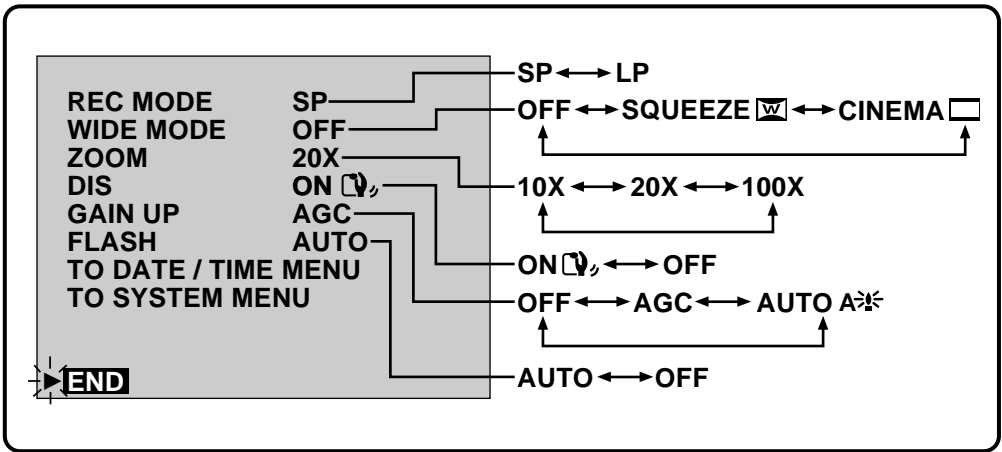

## REC MODE (Recording mode)

You can change the tape recording speed. LP tape speed is slower than SP, allowing LP to record 1.5 times longer than SP. If you have shot in SP mode Audio Dubbing and Insert Editing will be possible later.

### NOTE:

*Tapes shot in LP mode are recommended to be played back on this unit. Playback may not be successful on other units.*

## WIDE MODE

This recording mode is compatible with wide-screen TVs (16:9 aspect ratio). When using this mode, please refer to your wide-screen TV's instruction manual.

**SQUEEZE** [w] –For playback on TVs with an aspect ratio of 16:9. Naturally expands the image to fit the screen without distortion. [w] appears. During playback/recording on 4:3 TVs/LCD monitor/viewfinder, the image is elongated vertically.

**CINEMA** [c] –Inserts black bands at the top and bottom of the screen. During playback on wide-screen TVs, the black bands at the top and bottom of the screen are cut and the screen ratio becomes 16:9. During playback/recording on 4:3 TVs/LCD monitor/viewfinder, black bands are inserted at the top and bottom of the screen and the image appears like a letterboxed 16:9 movie.

**OFF**–Select “OFF” when you don’t want to use either of the above modes.

A discriminating signal is automatically recorded when you select either “SQUEEZE” or “CINEMA” for recording. If your wide TV has the automatic discriminating function, connect an S-Video cable between S2 connector on the TV and the S-Video output connector on the Docking Station. During playback, the image is naturally expanded to fit the wide screen, with no proportional distortion.

If your wide screen TV has no S2 connector, automatic signal discrimination can not be performed, and it should be done manually.

### NOTES:

- When playing back through a video cassette recorder, or to a wide-screen TV, that does not have the automatic discriminating function, change the setting on the TV manually.
- When playing back a tape recorded in Squeeze and Cinema, Squeeze cannot be distinguished from Cinema during fast-forward or rewind.
- During Full-Auto operation, both Squeeze and Cinema modes are unusable.

## ZOOM (Zoom magnification)

You can select 10X, 20X, or 100X maximum zoom magnifications.

**10X**—Optical zoom that does not degrade the quality of the recording.

**20X**—Electronic processing (Digital zoom) that lets you get closer up.

**100X**—Electronically-processed images at 100-times magnification.

### NOTES:

- Even if 20X or 100X is selected, Digital zoom (magnification of over 10X) cannot be used while the Video Echo effect (☞ pg. 43), the Picture Wipe/Dissolve function (☞ pg. 38) or the 5SD mode (☞ pg. 28) are activated.
- During Full-Auto mode, 20X is selected automatically.

## DIS (Digital Image Stabilizer)

When recording while holding the camcorder in your hand, or when shooting a subject with little or no contrast, subtle hand movements will cause shakiness in the recorded image.

**ON** (📷) —Compensates for relatively small shakes that occur when shooting close up. “📷” appears during recording.

**OFF**—When shooting with the camcorder in a fixed position or on a tripod, set the Stabilizer to “OFF”.

If you leave it on and then move or turn the camera to follow a moving subject, unnecessary compensation occurs and this can result in an unnatural recorded image.

### NOTES:

- Even if the stabilizer is set to “OFF” in Manual mode, it is automatically set to “ON” in Full Auto Mode.
- The Stabilizer cannot compensate for drastic hand movements while shooting.
- The Stabilizer will not work when certain P.AE/ Effects (Classic Film, Strobe, Slow 1, 2 ☞ pg. 43) and Fade/Wipe Effects (Picture Wipe/Dissolve ☞ pg. 38) are activated or if the scene has little or no contrast. The “📷,” indicator appears blinking.

## GAIN UP

Bright, natural recordings can be taken even in areas with low or poor lighting.

**AUTO** (📷) —The shutter speed is automatically adjusted (1/25 — 1/200 sec.). Shooting a subject in low or poor lighting at 1/25 sec. shutter speed provides a brighter image than in the AGC mode, but the subject’s movements are not smooth nor natural. When set to this mode, “📷” is displayed.

**OFF**—Select this setting when lighting is not a problem.

**AGC**—This is the factory setting, and is automatically activated during Auto operation. The overall appearance is jagged, but the image is bright and the movements are more natural than in “📷” mode.

## FLASH (☞ pg. 26)

When a snapshot is taken in the dark, the camcorder automatically uses the flash. To disable this function, set it to “OFF”.

### NOTES:

- Even when the flash is set to “OFF” in Manual mode, it is automatically set to “AUTO” in Full Auto mode.
- Images shot with the flash set to “AUTO” :  
Although images shot with a flash tend to look whiter than they actually are, to compensate for this camcorder automatically darkens the picture when using the flash. When shooting a subject at a distance where the flash light cannot reach (over 2 m), set the flash to “OFF” to prevent the picture from becoming too dark.



## Displaying The Date And Time During Recording

When the Power Dial is set to "M", "5S" or "S", you can choose whether to display the date and time during recording or not. You must first set the date and time (see "Date/Time Settings"  pg. 11). Set "DISPLAY" to "ON" in the Date/Time Menu. The Date/Time is always displayed when the Power Dial is set to "A".

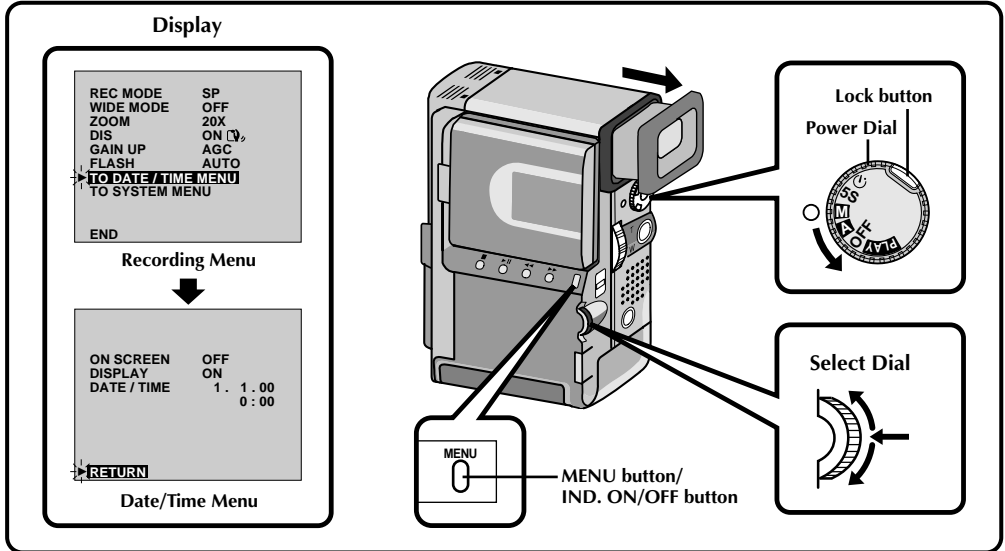

**1 SELECT OPERATION MODE**  
First turn the Power Dial to "M" while pressing down the lock button located on the dial, make sure the LCD monitor is open fully or the viewfinder is pulled out.

**2 ACCESS RECORDING MENU**  
Press MENU. The Recording Menu appears.

**3 ACCESS DATE/TIME MENU**  
Move the pointer and highlight bar to "TO DATE/TIME MENU" by rotating the Select Dial. Press it and the Date/Time Menu appears.

**4 SELECT FUNCTION**  
Move the pointer and highlight bar to "DISPLAY" by rotating the Select Dial, then press it. The pointer stops blinking, indicating that the function has been selected.

**5 SET FUNCTION PARAMETERS**  
Cycle through the available settings of the selected functions by rotating the Select Dial and stop when the one you want is displayed. Then press it and the pointer and highlight bar automatically move to "RETURN".

**6 CLOSE RECORDING MENU**  
Press the Select Dial twice. Selection is complete and the menu disappears.

### NOTES:

- Connect the camcorder to a TV and set "ON SCREEN" to "ON" in the Date/Time Menu. The display appears on the connected TV.
- The Indicator/Display function overrides these settings. Even if you have set "ON SCREEN" to "ON", pressing the IND. ON/OFF button for longer than 1 second removes the indications from the screen. Pressing it for longer than 1 second again makes the indications re-appear.

## System Menu

The System Menu allows you to set the following functions: *Photo Frame, Scene, Beep/Tally, Wind Cut, Sound Mode and ID numbers.*

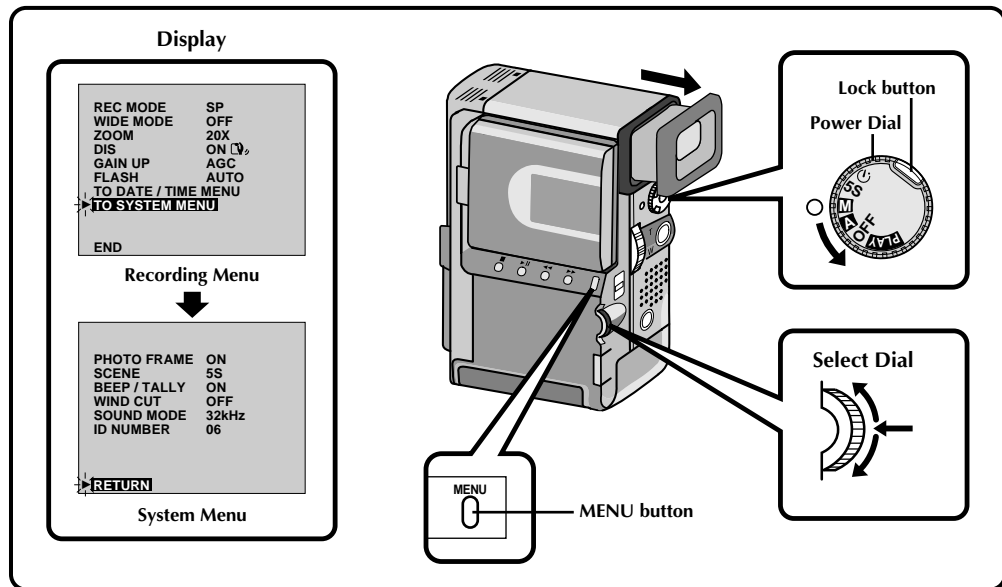

### 1 SELECT OPERATION MODE

First turn the Power Dial to "M" while pressing down the lock button located on the dial, make sure the LCD monitor is open fully or the viewfinder is pulled out.

### 2 ACCESS RECORDING MENU

Press MENU. The Recording Menu appears.

### 3 ACCESS SYSTEM MENU

Move the pointer and highlight bar to "TO SYSTEM MENU" by rotating the Select Dial, then press it. The System Menu appears.

### 4 SELECT FUNCTION

Place the pointer and highlight bar to the desired function by rotating the Select Dial, then press it. The pointer stops blinking, indicating that the function has been selected.

### 5 SET FUNCTION PARAMETERS

Rotate the Select Dial to cycle through the available settings for the selected function, and stop when the desired setting appears. Then press it, and the pointer and highlight bar automatically move to "RETURN".

- To set the parameters for a different function, repeat steps 4 and 5.

### 6 CLOSE SYSTEM MENU

Press the Select Dial twice. Setting is complete and the System Menu disappears.

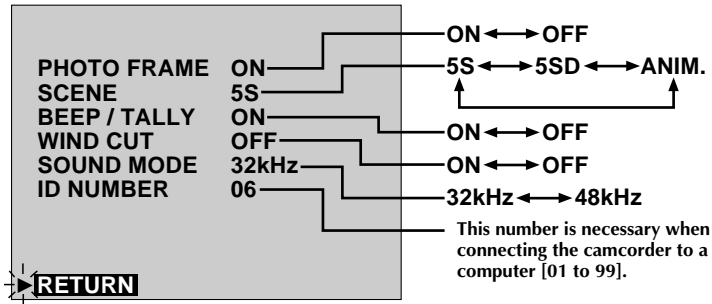

## PHOTO FRAME

The snapshot function (☞ pg. 25) has two types of photo effects; with frame and without frame.

**ON**—When engaged during recording, there will be a momentary camera shutter-type blackout, a shutter sound effect is recorded on the tape, and a white-bordered still image is displayed and recorded.

**OFF**—When engaged during recording, a still image is displayed and recorded.

### NOTE:

*Photo Frame cannot be set to OFF during Full Auto operation.*

## SCENE (5-Second Mode) (☞ pg. 28)

**5S**—Pressing **START/STOP** allows you to take a 5-second “clip”. Press repeatedly for a succession of short recordings.

**5SD**—If you record a 5-second clip within 5 minutes after the previous one, the end of the old scene dissolves and is replaced by the new scene over a 2-second period.

**ANIM. (Animation)**—Each time you press **START/STOP**, a 1/8-second recording is taken. By using an inanimate object and changing its position between shots, you can record the subject as though it’s moving.

- *Animation is not available in the LP mode. If you tried to record in the LP mode after setting ANIM., the recording mode indicator “LP” begins to blink, and recording goes on in the SP mode.*

### NOTE:

*During use of SCENE effect, focus (☞ pg. 44) and exposure control (☞ pg. 45) enter Full Auto operation.*

## BEEP/TALLY

The beep sounds when the power is turned on or off, and at the beginning and end of recording.

Tally lamp lights up during recording.

Shutter sound is heard when pressing the **SNAP-SHOT** button.

**ON**—To activate the beep/shutter sounds and tally lamp.

**OFF**—To turn off the beep/shutter sounds and tally lamp. Even though not heard while shooting, shutter sound is recorded on the tape.

### NOTE:

*Beep/Tally is automatically turned on during Full Auto operation.*

## WIND CUT

When activated, this mode helps cut down on noise created by wind.

**ON**—When shooting in high winds, noise is automatically reduced.

- “” appears.
- The quality of the sound will change. This is normal.

**OFF**—This function is disabled.

### NOTE:

*The Wind Cut mode is disabled during Full Auto operation.*

## SOUND MODE

Sound signals can be sampled at 32 kHz or 48 kHz.

**32 kHz**—The camcorder is factory-preset for 32 kHz. This setting enables recording of stereo sound on four separate channels, and is recommended for use when performing Audio Dubbing.

**48 kHz**—This setting enables recording of stereo sound on two separate channels.

### NOTE:

*A tape recorded at 48 kHz cannot be used for Audio Dubbing.*

## FADE/WIPE Effects

Use these to spice up the transition from one scene to the next. You can also vary transitions from scene to scene. Refer to pages 36 – 41 for Fade/Wipe effects and techniques.

Select any one effect from the Fader/Wipe Menu.

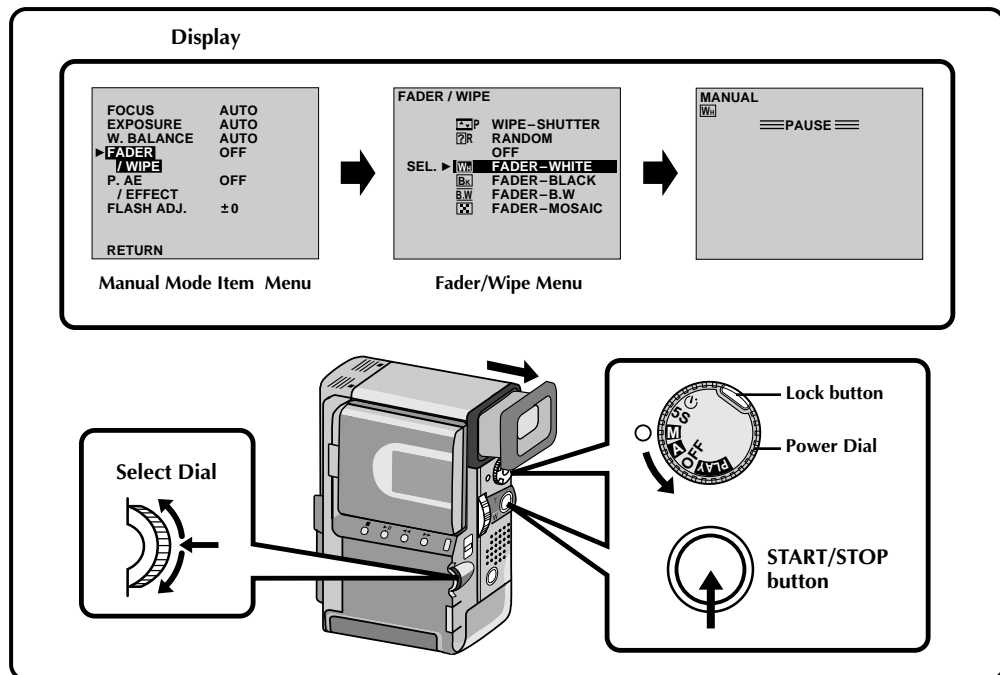

### 1 SELECT OPERATION MODE

First turn the Power Dial to “M” while pressing down the lock button located on the dial, make sure the LCD monitor is open fully or the viewfinder is pulled out.

### 2 ACCESS MANUAL MODE ITEM MENU

Press the Select Dial.

### 3 ACCESS FADER/WIPE MENU

Move the pointer and highlight bar to “FADER/WIPE” by rotating the Select Dial and then press it. The Fader/Wipe Menu appears.

### 4 SELECT EFFECT

Move the pointer and highlight bar to the desired effect by rotating the Select Dial, then press it.

- The Fader/Wipe Menu disappears and the effect is reserved. The indicator representing the selected effect appears.

### 5 START RECORDING

Press **START/STOP** to start recording and activate fade- or wipe- in

**OR...**

### END RECORDING

Press **START/STOP** to end recording and activate fade- or wipe- out.

### 6 TO CANCEL FADE/WIPE EFFECTS

In step 4, move the pointer and highlight bar to “OFF”. Press the Select Dial.

### NOTE:

If certain P.AE/Effects (pg. 42) are activated, some Fade/Wipe Effects cannot be used. If you select a Fade/Wipe Effect that is unusable in the current situation, the indication blinks.

## Fades and Wipes

A scene gradually appears on a black or white screen (Fade In/Wipe In), or disappears, leaving a black or white screen (Fade Out/Wipe Out). Select Fade or Wipe at the Fader/Wipe Menu (pg. 36).

Select any one effect from **WH**, **BK**, **BW**, **XX**, **□**, **□**, **◀**, **▶**, **▲**, and **▼** of the Fader/Wipe Menu.

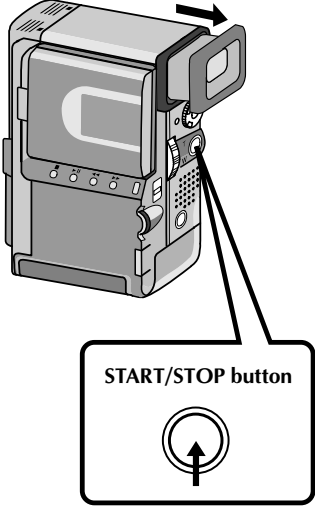



The diagram shows a camcorder with an arrow pointing to the START/STOP button. A callout box below the camcorder shows the START/STOP button, which is a circular button with an upward-pointing arrow.

**FADE**

Example **WH** FADER – WHITE

Fade In →







← Fade Out

**WIPE**

Example **▲** WIPE – SCROLL

Wipe In →





← Wipe Out

- 1 ACTIVATE FADE IN OR WIPE IN**  
 Press **START/STOP** to start recording, and the Fade In or Wipe In occurs automatically.
- 2 ACTIVATE FADE OUT OR WIPE OUT**  
 When you want to stop recording the scene, press **START/STOP**. Before the camcorder enters the Record-Standby mode, the Fade Out or Wipe Out occurs automatically.

### NOTE:

You can extend the length of a fade or wipe by pressing and holding the **START/STOP** button.

## Picture Wipe/Dissolve

Combine the Picture Wipe and Dissolve functions for a professional transition effect. There are 6 Picture Wipe effects and 1 Dissolve effect. Select the Picture Wipe effect at the Fader/Wipe Menu (  pg. 36).

Select any one effect from P, P, P, P, P, P and P of the Fader/Wipe Menu.

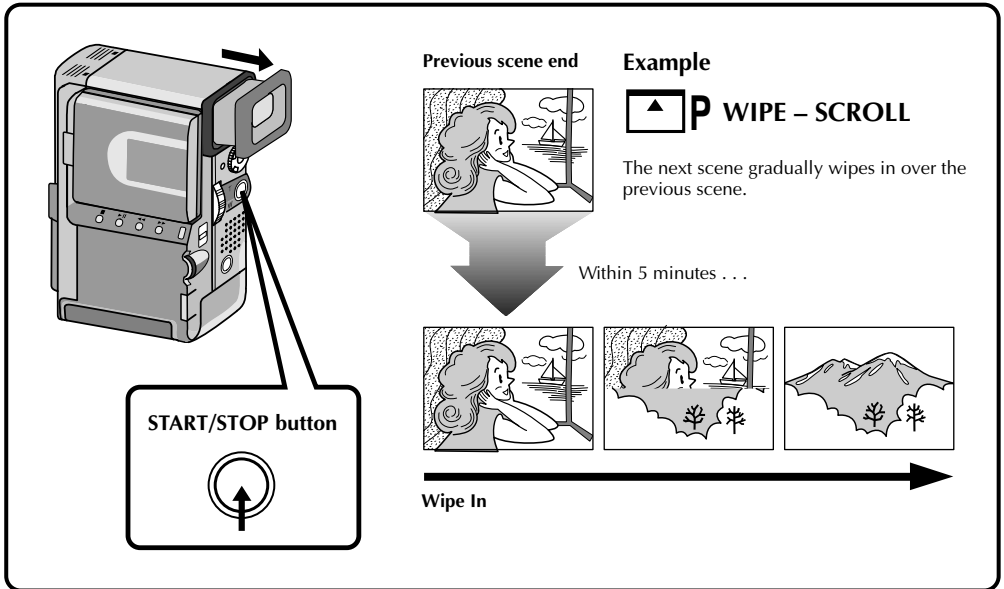

### 1 START RECORDING

Press START/STOP.

### 2 ENGAGE RECORD-STANDBY MODE

Press START/STOP when one scene is finished. The point at which the scene ended is stored in memory.

### 3 RESUME RECORDING

If you start recording a new scene within 5 minutes of the end of the previous recording (without having turned the camcorder's power off), the previous scene wipes out, revealing the new scene.

## NOTES:

- If you turn off the power after having finished recording a scene, the stored point is erased. This disables the Picture Wipe/Dissolve combination. When this happens, the Picture Wipe/Dissolve indicator blinks. Try recording again, but don't turn the power off when you're finished. Please be advised that power also shuts off automatically if 5 minutes elapse in the Record-Standby mode. The camcorder stores the end point of the last recorded scene, and you can use Picture Wipe/Dissolve between the last scene and the next one.
- The sound at the end of the last recorded scene is not stored.

## Random Variations

When **VR** is selected, the camcorder chooses one of the fades/wipes at random.

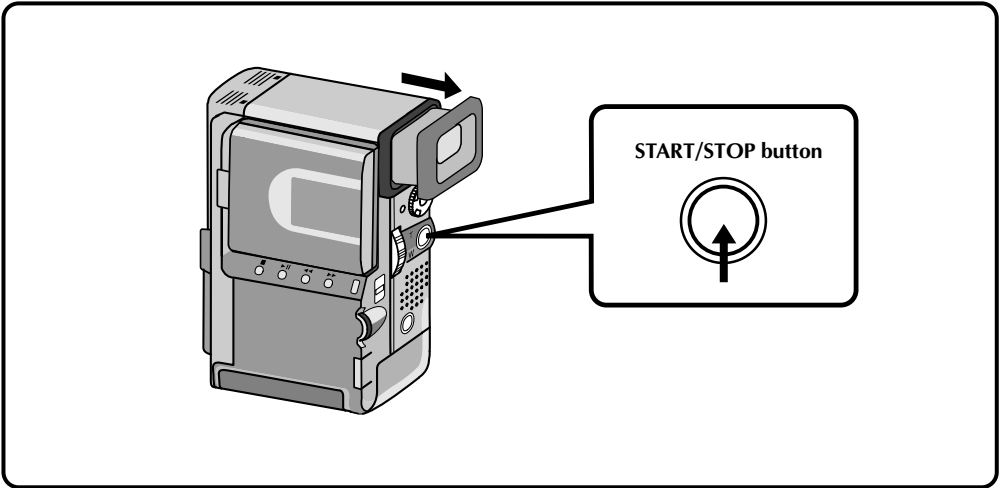
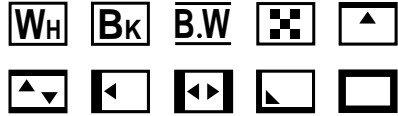

### 1 START RECORDING











Press **START/STOP**. The camcorder does the rest, selecting an effect at random.

- The recording starts with a Fade In or Wipe In. If you press **START/STOP** during recording, Record-Standby mode is preceded by a Fade Out or Wipe Out; when you resume recording, it begins with a Fade In or Wipe In.









### NOTE:

*The Picture Wipe/Dissolve feature is not available when Random Fader is activated.*

## FADER AND WIPE MENU

MENU	EFFECT
 <b>FADER — WHITE</b>	Fade in or out with a white screen.
 <b>FADER — BLACK</b>	Fade in or out with a black screen.
 <b>FADER — B.W</b>	Fade in to a colour screen from a black and white screen, or fade out from colour to black and white.
 <b>FADER — MOSAIC</b>	Fade in or out with a full-screen mosaic effect.
 <b>WIPE — CORNER</b>	Wipe in on a black screen from the upper right to the lower left corner, or wipe out from lower left to upper right, leaving a black screen.
 <b>WIPE — WINDOW</b>	The scene starts in the centre of a black screen and wipes in toward the corners, or comes in from the corners, gradually wiping out to the centre.
 <b>WIPE — SLIDE</b>	Wipe in from right to left, or wipe out from left to right.
 <b>WIPE — DOOR</b>	Wipe in as the two halves of a black screen open to the left and right, revealing the scene, or wipe out and the black screen reappears from left and right to cover the scene.
 <b>WIPE — SCROLL</b>	The scene wipes in from the bottom to the top of a black screen, or wipes out from top to bottom, leaving a black screen.
 <b>WIPE — SHUTTER</b>	Wipe in toward the centre of a black screen from the top and bottom, or wipe out from the centre toward the top and bottom, leaving a black screen.



MENU	EFFECT
 <b>P DISSOLVE</b>	The new scene gradually appears as the old one gradually disappears.
 <b>P WIPE — CORNER</b>	The new scene wipes in over the previous one from the upper right corner to the lower left corner.
 <b>P WIPE — WINDOW</b>	The next scene gradually wipes in from the centre of the screen toward the corners, covering the previous scene.
 <b>P WIPE — SLIDE</b>	The next scene gradually wipes in over the previous one from right to left.
 <b>P WIPE — DOOR</b>	The previous scene wipes out from the centre to the right and left, like a door being pushed open to reveal the next scene.
 <b>P WIPE — SCROLL</b>	The new scene wipes in over the last one from the bottom of the screen to the top.
 <b>P WIPE — SHUTTER</b>	The new scene wipes in over the previous one from the center toward the top and bottom of the screen.
 <b>R RANDOM</b>	When this function is activated, the camcorder randomly selects the effect used in scene transition (from the Fade and Wipe effects).

## P.AE/Effects

You can choose any one of the effects from the P.AE/Effects Menu.

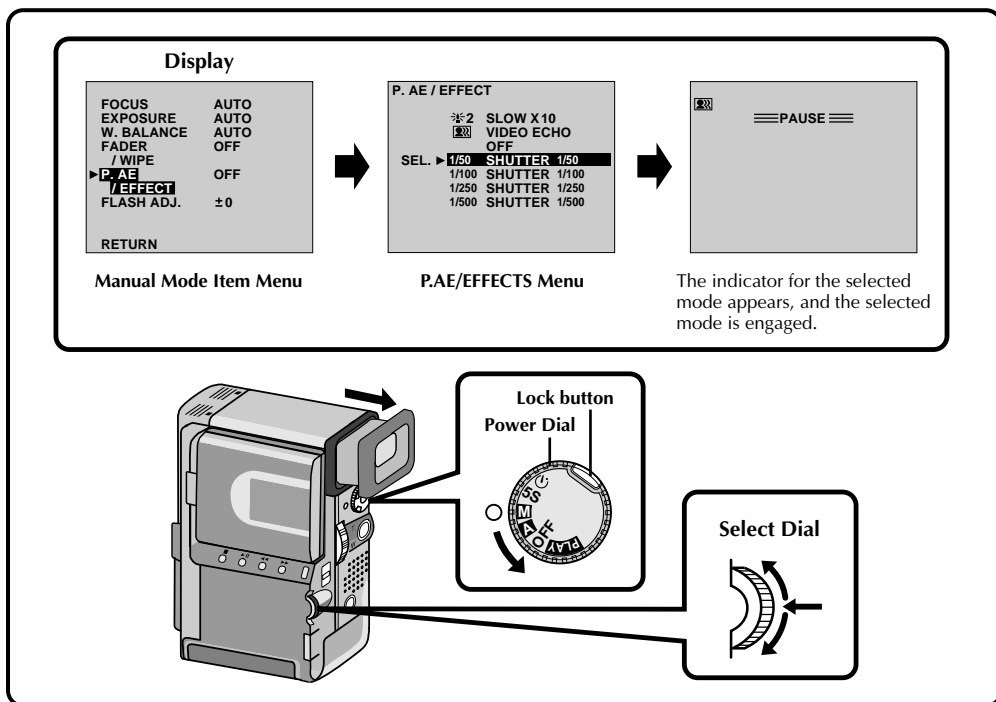

### 1 SELECT OPERATION MODE

First turn the Power Dial to "M" while pressing down the lock button located on the dial, make sure the LCD monitor is open fully or the viewfinder is pulled out.

### 2 ACCESS MANUAL MODE ITEM MENU

Press the Select Dial and move the pointer and highlight bar to "P.AE/EFFECT" by rotating the Select Dial.

### 3 ACCESS P.AE/EFFECTS SELECT MENU

Press the Select Dial. The P.AE/Effects Menu appears.

### 4 SELECT EFFECT

Move the pointer and highlight bar to the desired effect by rotating the Select Dial, then press it.

- The P.AE/Effects Menu disappears and the selected mode is activated. The symbol of the selected mode appears.

### 5 DISABLE P.AE/EFFECT

To turn off the selected effect, re-access the P.AE/Effects Menu and move the pointer and highlight bar to "OFF" by rotating the Select Dial. Then press it.

### NOTES:

- P.AE/Effects can be changed during recording or during Record-Standby.
- If certain Fades or Wipes (see pg. 36 – 41) are activated, some P.AE/Effects cannot be used. If you select a P.AE/Effect that is unusable in the current situation, the effect's symbol begins flashing.



### SHUTTER (Variable Shutter Speed)

**1/50**—The shutter speed is fixed at 1/50th of a second. Black bands that usually appear when shooting a TV screen become narrower.

**1/100**—The shutter speed is fixed at 1/100th of a second. The flickering that occurs when shooting under a fluorescent light or mercury-vapour lamp is reduced.

**1/250, 1/500**—These settings allow fast-moving images to be captured one frame at a time, for vivid, stable slow-motion playback. The faster the shutter speed, the darker the picture becomes. Use the shutter function under good lighting conditions.



### CLASSIC FILM

Gives recorded scenes a strobe effect.



### STROBE

Your recording looks like a series of consecutive snapshots.

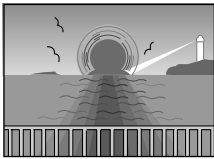

### TWILIGHT

Makes evening scenes look more natural. White Balance (pg. 47) is initially set to , but can be changed to your desired setting. Also when Twilight is chosen, the manual focus indication appears.



### SEPIA

Recorded scenes have a brownish tint like old photos. Combine this with the Cinema mode for a classic look.

### B/W MONOTONE

Like classic black and white films, your footage is shot in B/W. Used together with the Wide Cinema function, it enhances the “classic film” effect.

### SLOW (Slow Shutter)

You can light dark subjects or areas even brighter than they would be under good natural lighting.



**1** × 4 = 4 times sensitivity  
(shutter speed 1/12.5 sec.)



**2** × 10 = 10 times sensitivity  
(shutter speed 1/5 sec.)

### NOTES:

- When using Slow, the image takes on a strobe-like effect.
- Use Slow only in dark areas.
- The Manual Focus indication may appear and flash when Slow is in use.
- If the image is out of focus, adjust manually. It is also recommended that you use a tripod, if possible.



### VIDEO ECHO

Adds a “ghost” to the subject, giving your recording a “fantasy” feeling.

## Manual Focus Adjustment

The camcorder, in most cases, adjusts the focus from approx 3 cm to infinity automatically. However, when focusing is difficult or when the subject is not in the middle of the LCD monitor or the viewfinder, adjust the focus manually.

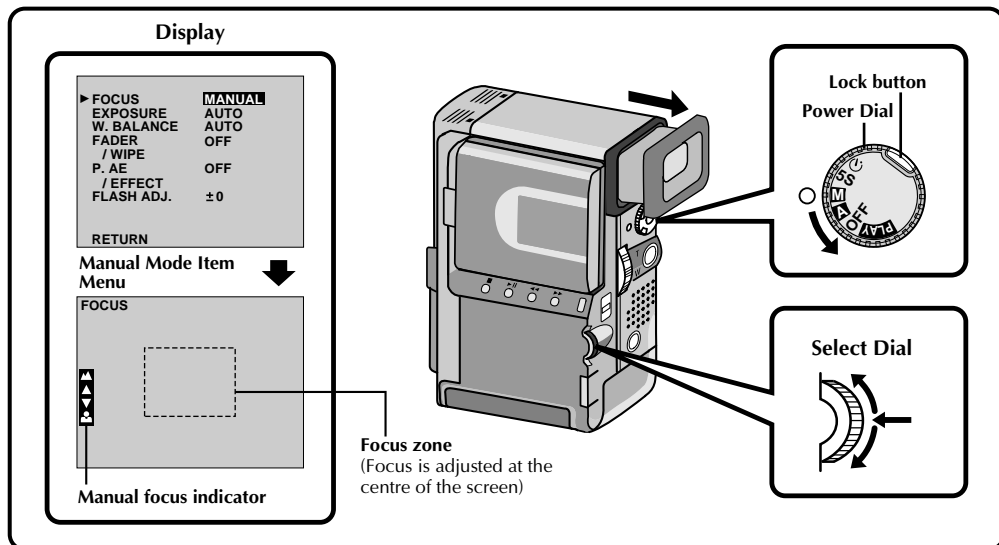

### 1 SELECT OPERATION MODE

First turn the Power Dial to "M" while pressing down the lock button located on the dial, make sure the LCD monitor is open fully or the viewfinder is pulled out.

### 2 ACCESS MANUAL MODE ITEM MENU

Press the Select Dial. The Manual Mode Item Menu appears.

### 3 ACCESS MANUAL FOCUS

Move the pointer and highlight bar to "FOCUS" by rotating the Select Dial, then press it. Rotate the Select Dial to display "MANUAL", then press it. The Manual Mode Item Menu disappears and "FOCUS" is displayed in the upper left corner. The focus is locked at this point.

### 4 ADJUST FOCUS

Rotate the Select Dial.

- "▲" blinks while rotating the Select Dial upward to focus on faraway targets, and "▼" blinks while rotating the Select Dial downward to focus on closer targets. Press the Select Dial at your desired focus.
- When the focus reaches its near or far limit, the "▲" or "▼" will begin blinking.
- When focus cannot be adjusted manually, try zooming in or out, then try the manual focus adjustment again.

### 5 END ADJUSTMENT OF FOCUS

Focus adjustment is complete. The indication changes from "FOCUS" to "MANUAL".

- If you want to reset the focus, repeat from Step 2.

#### To Change To Auto Focus . . .

.... Rotate the Select Dial to display "AUTO", then press it in step 4. The manual focus indicators disappear. Or set the Power Dial to "A".

#### NOTES:

- When "FOCUS" is not displayed, Manual Focus Adjustment is not available. To make it appear, press the **IND.ON/OFF** for longer than 1 second or repeat from Step 2.
- Manual focus is recommended in the following situations:
  - When shooting a flat wall, a blue sky or an object with little or no contrast.
  - When wire or other obstacles come between the camcorder and the subject.
  - When shooting objects with a detailed design or pattern.
  - When shooting under fluorescent or flickering lighting.

## Exposure Control

Usually this is adjusted automatically. However, when the background is too bright or too dark in comparison with the subject, the exposure could be corrected manually.

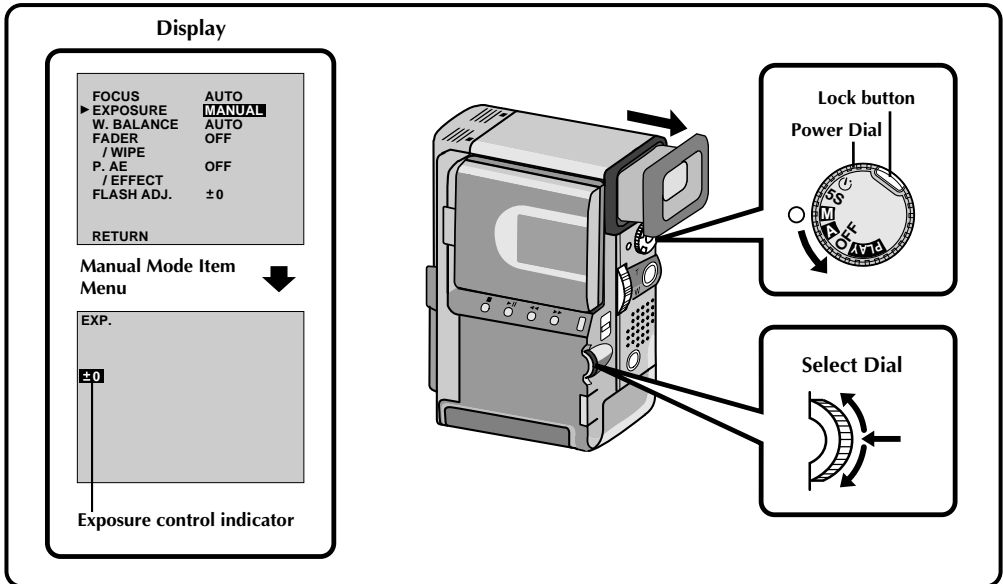

### 1 SELECT OPERATION MODE

First turn the Power Dial to "M" while pressing down the lock button located on the dial, make sure the LCD monitor is open fully or the viewfinder is pulled out.

### 2 ACCESS MANUAL MODE ITEM MENU

Press the Select Dial. The Manual Mode Item Menu appears.

### 3 ACCESS EXPOSURE CONTROL

Move the pointer and highlight bar to "EXPOSURE" by rotating the Select Dial, then press it. Rotate the Select Dial to display "MANUAL", then press it. The Manual Mode Item Menu disappears and "EXP." and the Exposure Control indicator are displayed.

### 4 ADJUST EXPOSURE

Rotate the Select Dial upward/downward to brighten or darken the image. Press the Select Dial at your desired exposure.

- The adjustment range is from -6 to +6.

### 5 END ADJUSTMENT OF EXPOSURE

Exposure adjustment is complete. The indication "EXP." changes to "MANUAL".

### To Return To Automatic Exposure Control . . .

.... Rotate the Select Dial to display "AUTO", then press it in step 3. The Exposure Control indicator disappears. Or set the Power Dial to "A".

### NOTES:

- When "EXP." is not displayed, Manual Exposure Control is not available. To make it appear, press the **IND.ON/OFF** for longer than 1 second or repeat from step 2.
- Manual exposure adjustment is recommended in the following situations:
  - When shooting using reverse lighting or when the background is too bright.
  - When shooting on a reflective natural background such as at the beach or when skiing.
  - When the background is overly dark or the subject light.

### Brightness control of the LCD monitor

To adjust the brightness of the LCD monitor, rotate the Select Dial (see pg. 22). Note that the actual recorded image's brightness can not be changed by rotating this dial.

## Iris Lock

Use this function when shooting a moving subject, when zooming, when the subject changes its distance (thus its size in the LCD monitor or the viewfinder), or when you want to lock the brightness level.

When the subject is close, keep the iris locked. Even when the subject moves away from you, the image will not darken.

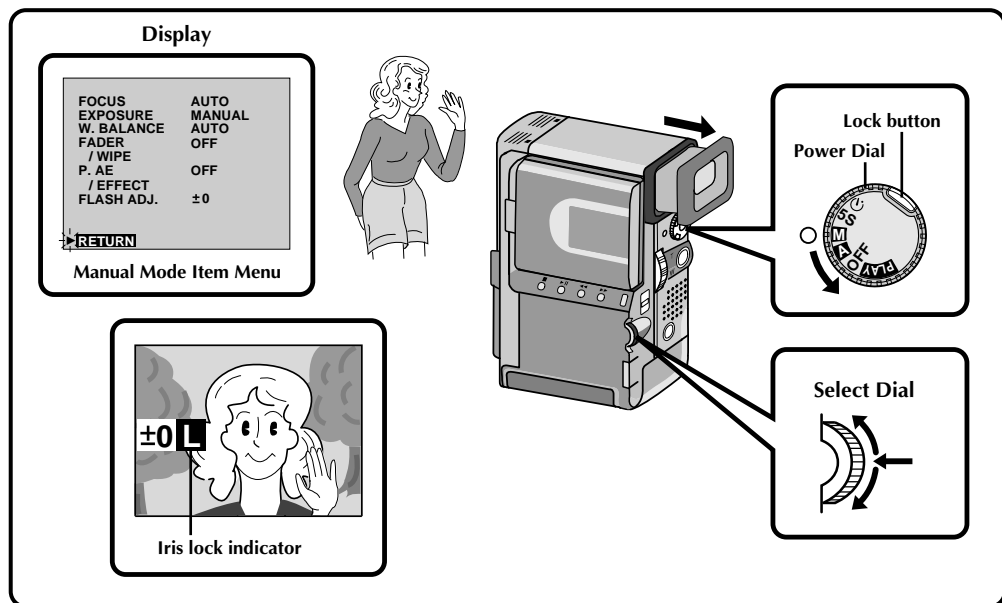

### 1 SELECT OPERATION MODE

First turn the Power Dial to "M" while pressing down the lock button located on the dial, make sure the LCD monitor is open fully or the viewfinder is pulled out.

### 2 ACCESS MANUAL MODE ITEM MENU

Press the Select Dial. The Manual Mode Item Menu appears.

### 3 ACCESS EXPOSURE CONTROL

Move the pointer and highlight bar to "EXPOSURE" by rotating the Select Dial and then press it. Rotate the Select Dial to display "MANUAL", then press it. "EXP." is displayed.

### 4 CENTER SUBJECT, LOCK IRIS

Adjust zoom so that the subject fills the LCD monitor or the viewfinder, then press and hold the Select Dial for over 2 seconds. The exposure setting display and "L" appear, indicating that the iris is locked. Press the Select Dial. The indication displayed in the upper left corner changes from "EXP." to "MANUAL".

### To Return To Automatic Iris Control . . .

.... Rotate the Select Dial to display "AUTO", then press it in step 3. The Exposure Control indicator and "L" disappear. Or set the Power Dial to "A".

### NOTES:

*Iris lock is recommended in the following situations:*

- When shooting on a reflective natural background such as at the beach or when skiing.
- When shooting objects under a spotlight.
- When the subject is backing away.
- When zooming.

### To lock the exposure control and the iris . . .

.... After step 3, adjust the exposure rotating the Select Dial. Then lock the iris in step 4. For automatic locking, rotate the Select Dial to display "AUTO", then press it in step 4. The iris becomes automatic after about 2 seconds.

### Iris

Works like the pupil of the human eye. In a well-lit environment, the human pupil contracts to keep too much light from entering. In low lighting, the pupil dilates to allow more light in.

## White Balance Adjustment

A term that refers to the correctness of colour reproduction under various lighting. If the white balance is correct, all other colours will be accurately reproduced.

The white balance is usually adjusted automatically. However, the more advanced camcorder operator would prefer to control this function manually and achieve a more professional colour/tint reproduction.

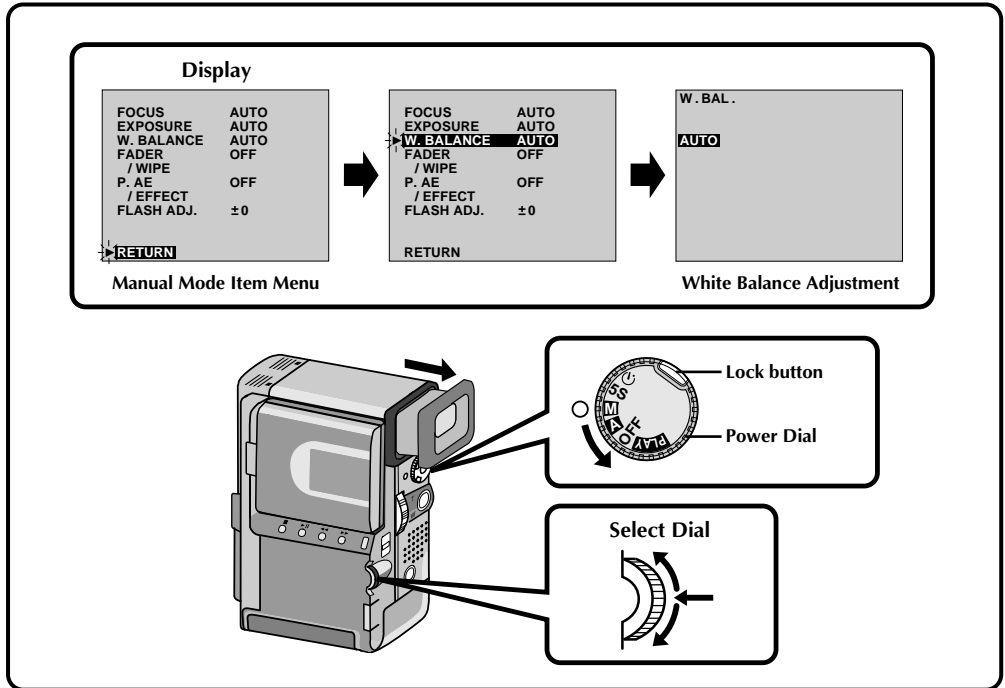

### 1 SELECT OPERATION MODE

First turn the Power Dial to "M" while pressing down the lock button located on the dial, make sure the LCD monitor is open fully or the viewfinder is pulled out.

### 2 ACCESS MANUAL MODE ITEM MENU

Press the Select Dial. The Manual Mode Item Menu appears.

### 3 ACCESS WHITE BALANCE ADJUSTMENT

Move the pointer and highlight bar to "W.BALANCE" by rotating the Select Dial. Then press it. The Manual Mode Item menu disappears and "W.BAL." appears in the upper left corner and "AUTO" appears on the screen.

### 4 SET FUNCTION PARAMETERS

Cycle through the available settings of the selected functions by rotating the Select Dial, and stop when the one you want is displayed.

### 5 CLOSE WHITE BALANCE ADJUSTMENT

Press the Select Dial again. Selection is complete. The indication "W. BAL." changes to "MANUAL".

#### To Return To Automatic White Balance . . .

.... select "AUTO" in step 3. Or set the Power Dial to "A".

#### NOTE:

White balance cannot be used when P.AE/Effects Sepia or Monotone are activated.

**AUTO**—The white balance is adjusted automatically. This is the factory preset position.

☀— When using a video light or other similar type of lighting.

☁— When shooting outdoors on a cloudy day.

☀— When shooting outdoors on a sunny day.

☑— When shooting with the white balance already having been set on the subject (☞ pg. 48).

## Manual White Balance Operation

If the camera is operating in manual mode, perform a Manual White Balance when shooting under various types of lighting

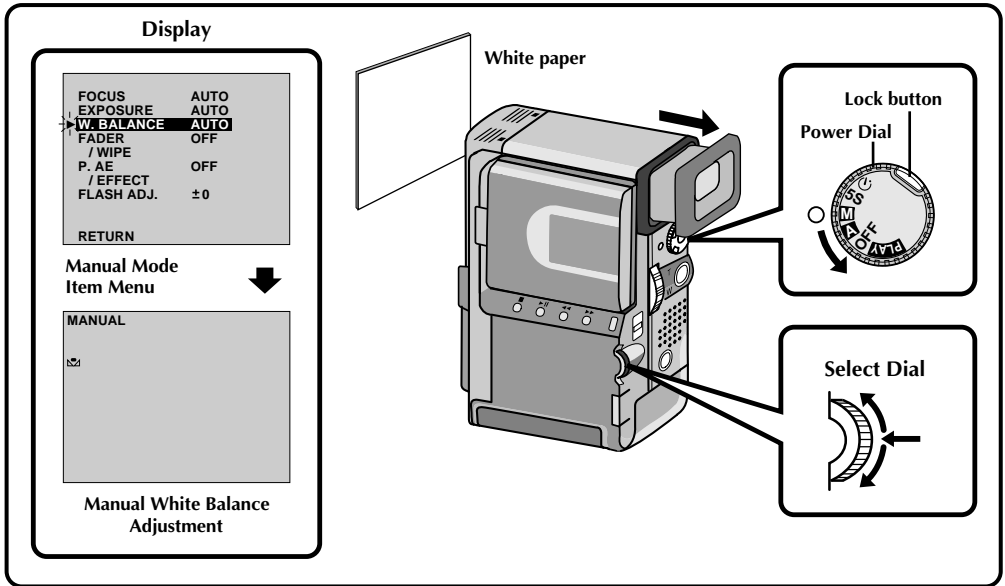

### 1 SELECT OPERATION MODE

Follow steps 1 through 4 of the white balance adjustment (pg. 47), select "MAN.".

### 2 SET MANUAL WHITE BALANCE

Hold a sheet of plain white paper in front of the subject. Adjust zoom or position yourself so that the white paper fills the screen.

### 3 ENTER SETTING

Press the Select Dial until the  begins blinking.

- When the setting is completed, the  stops blinking.

### 4 EXIT MANUAL WHITE BALANCE ADJUSTMENT

Press the Select Dial. The indication "W.BAL" changes to "MANUAL" and only the Manual White Balance indicator  is displayed.

## To Change The Tint For Recording . . .

.... In step 2, substitute coloured paper for white. The white balance is adjusted based on the colour, changing the tint. Red paper — deeper green; blue paper — orange; yellow paper — deeper purple.

## NOTES:

- A subject can be shot under various types of lighting conditions (natural, fluorescent, candlelight, etc.). Because the colour temperature is different depending on the light source, the tint of the subject will differ depending on the white balance settings. Use this function for a more natural result.
- Once you adjust white balance during Manual White Balance operation, the setting is retained even if the power is turned off or the battery removed.



You can watch what you've recorded in the LCD monitor.

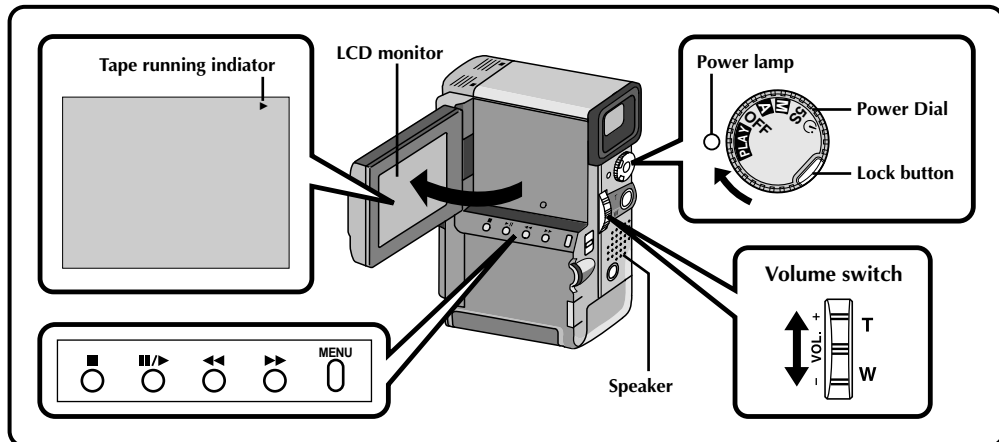

## 1 SELECT OPERATION MODE

Turn the Power Dial to "PLAY" while pressing down the lock button located on the dial. The Power lamp comes on.

## 2 OPEN LCD MONITOR

Open the LCD monitor.

- When the viewfinder is pulled out, the LCD monitor cannot be used.

## 3 REWIND TAPE

Press ◀◀. ◀◀ is displayed. If you rewind all the way to the end of the tape, it stops automatically.

## 4 VIEWING RECORDING

Press ▶▶. ▶▶ appears and the recorded footage can be viewed. The sound is heard from the speaker.

## 5 END PLAYBACK

Press ■. Set the Power Dial to "OFF".

- When turning to "OFF", it is not necessary to press down the lock button.

### To Perform High-Speed Search . . .

.... press ◀◀ or ▶▶ after pressing ▶▶. The tape will move at approximately 9 times the normal playback speed. Watch in the LCD monitor and, when you reach the spot you want to see, press ▶▶ and normal playback resumes.

.... during playback, press and hold ◀◀ or ▶▶. The search continues as long as you hold the button. Once you release it, normal playback resumes.

.... a slight mosaic effect appears on screen during High-Speed Search. This is not a malfunction.

### Playback Sound

You can hear sound from the speaker or using headphones connected to the headphones connector during playback. To adjust the sound volume, press the VOL. switch. The sound volume indication is displayed. Slide the VOL. switch towards "+" to turn up the volume, or towards "-" to turn it down.

### Still Playback

To temporarily stop playback, press ◻▶. Press again to resume playback. If still playback continues for more than about 3 minutes, the camcorder's Stop mode is automatically engaged. After 5 minutes in the stop mode, the camcorder's power is automatically turned off.

### Slow-Motion Playback

- To perform Slow-motion playback, the remote control is necessary.
- To change from normal to slow-motion playback, press the Pause button at the point where you want to start playback in slow motion, point the remote control at the remote sensor, and press the remote's Slow Rewind or Slow Forward button. After playing back in slow motion for about 10 to 20 seconds, normal playback resumes. Speed is 1/10 times normal. To stop slow-motion playback in progress, press the Play button.
- During slow-motion playback, due to digital image processing, the picture may take on a mosaic effect.
- After the Slow Rewind or Slow Forward button is pressed, the still image may be displayed for a few seconds, then the screen may become blue back for a few seconds. This is not a malfunction.
- There may be a small margin between the slow-motion playback start point you chose and the start point at which the camcorder actually begins playback in slow motion.

### NOTES:

- The sound is not available during High-Speed Search.
- Copy guarded tapes cannot be played back. The screen becomes blue back.

## Playback Zoom

The recorded pictures can be magnified up to 10X at any time during playback.

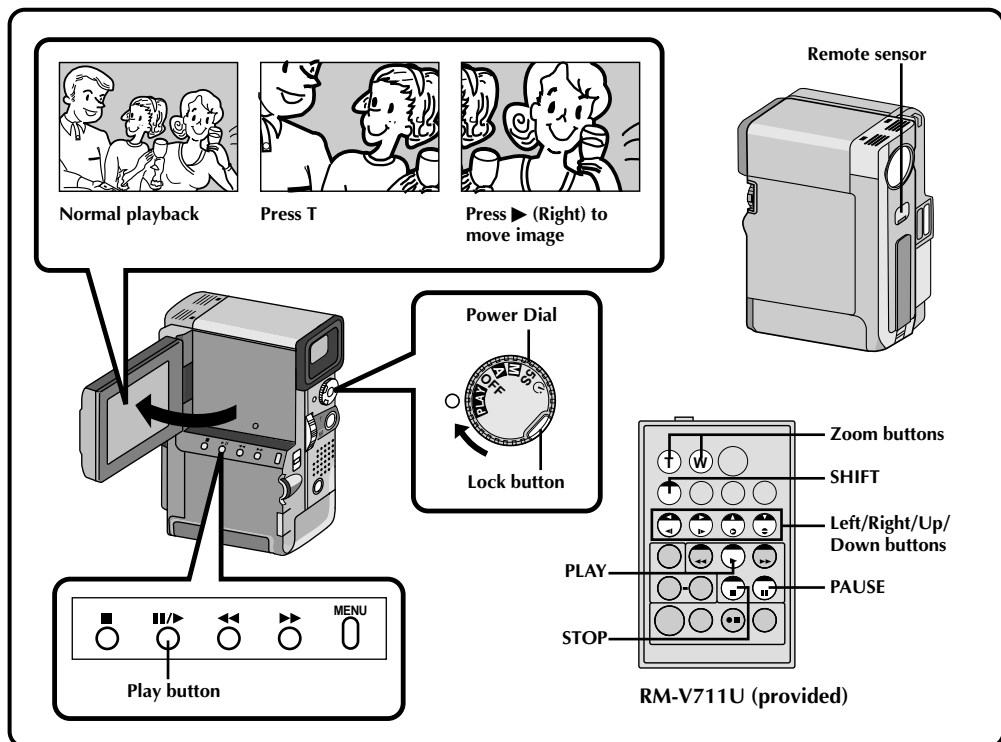

### 1 FIND THE SCENE OF INTEREST

Press the Play button to start playback.

### 2 ACTIVATE ZOOM

Press the zoom buttons (T/W) on the remote control. Make sure the remote control is pointed at the camcorder's remote sensor.

- Pressing T zooms in.

### 3 LOCATE PORTION OF MAGNIFIED SCENE

You can move the image on screen around to find a particular portion of the picture. While holding down **SHIFT**, press ◀ (Left), ▶ (Right), ▲ (Up) and ▼ (Down).

### 4 END ZOOM

Press and hold **W** until magnification returns to normal. Or, press **STOP** and then press **PLAY**.

### NOTES:

- Zoom can also be used during slow-motion and normal playback.
- If the Video Echo effect (pg. 51) is selected during playback zoom, playback zoom is cancelled.
- During digital image processing, the quality of the image may suffer.

## Playback Effects

These effects allow you to be creative with the playback picture. You can use any one of the 5 effects.

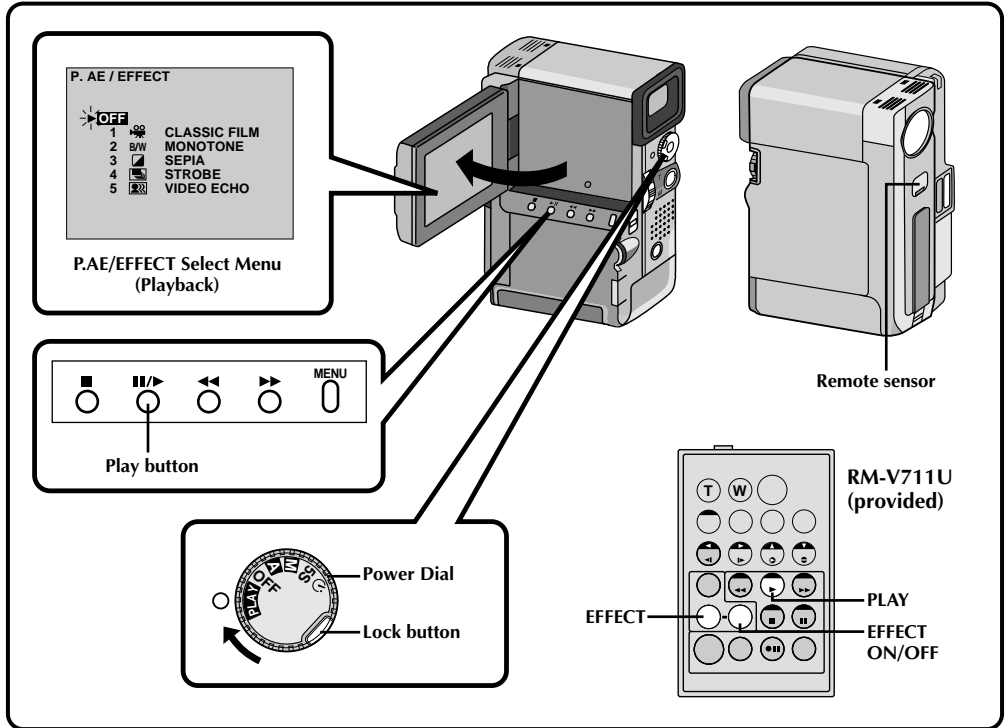

### 1 START PLAYBACK

Press the Play button.

### 2 ACCESS P.AE/EFFECT SELECT MENU

Point the remote control at the camcorder's remote sensor and press **EFFECT**. The P.AE/EFFECT Select Menu appears.

### 3 SELECT P.AE/EFFECT

Move the pointer and highlight bar to the desired effect by pressing **EFFECT**. The selected function is activated and after 2 seconds the menu disappears.

### NOTES:

- To deactivate the selected effect, press **EFFECT ON/OFF** on the remote control. Pressing it again re-activates the selected effect.
- Repeat from step 2 when you want to change the selected effect.

The effects that can be used during playback are *Classic Film*, *Monotone*, *Sepia*, *Strobe* and *Video Echo*. The effects work the same in playback as they did in recording. Refer to page 43 for more information.

## Playback Menu

The Playback Menu allows you to set the following functions:

Playback Sound (32 kHz, 48 kHz), Synchro Comp, Display and Time Code. The following procedure applies to all except Synchro Comp (☞ pg. 63, 64).

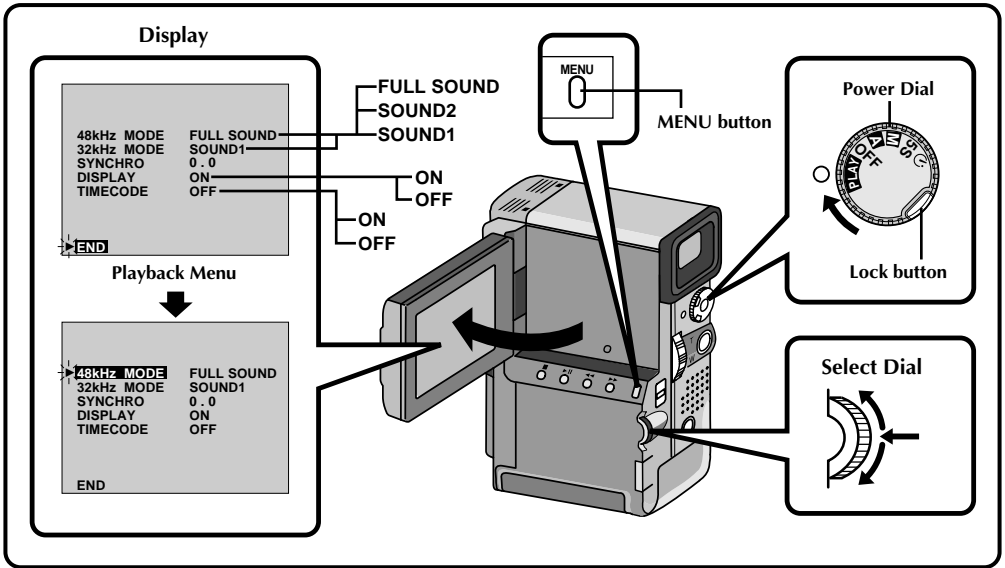

### 1 SELECT OPERATION MODE

First turn the Power Dial to "PLAY" while pressing down the lock button located on the dial. Open the LCD monitor fully.

### 2 ACCESS PLAYBACK MENU

Press MENU. The Playback Menu appears in the LCD monitor and on the connected TV.

### 3 SELECT FUNCTION

Move the pointer and highlight bar to the desired function by rotating the Select Dial. Press the Select Dial to activate.

### 4 SET FUNCTION PARAMETERS

Rotate the Select Dial to cycle through the available settings for the selected function, and stop when the desired setting appears. Then press the Select Dial, and the pointer and highlight bar automatically move to "END".

- To set parameters for other functions, repeat steps 3 and 4.

### 5 CLOSE MENU

Press the Select Dial again, and the menu disappears.

## Playback Sound

During playback, the camcorder detects the sound mode in which the recording was made, and plays the sound back. Select the type of sound to accompany your playback picture. (32 kHz is preset to "SOUND 1" and 48 kHz is preset to "FULL SOUND".)

RECORDING SOUND	DISPLAY	OUTPUT SOUND
32 kHz	FULL SOUND	Stereo sound
	SOUND 1	
	SOUND 2	
48 kHz	FULL SOUND	Stereo sound
	SOUND 1	"L" sound is output on both channels
	SOUND 2	"R" sound is output on both channels

When watching a tape recorded at 32 kHz, if you want to change the output sound, access the Playback Menu and, in step 3 on page 52, select "32kHz MODE" and set it for "FULL SOUND", "SOUND 1" or "SOUND 2". When playing back a tape recorded at 48kHz, set in the same manner. For information on output sound during Audio Dubbing, see page 65.

### NOTES:

- You can also use the RM-V711U remote control's **AUDIO MONITOR** Button to change the output sound (without having to access the Playback Menu). Make sure you point the remote control at the camcorder's remote sensor.
- During playback, the camcorder detects the sound mode in which the recording was made. This detection cannot be made during fast-forward or rewind. During playback the sound mode is displayed in the upper left corner.

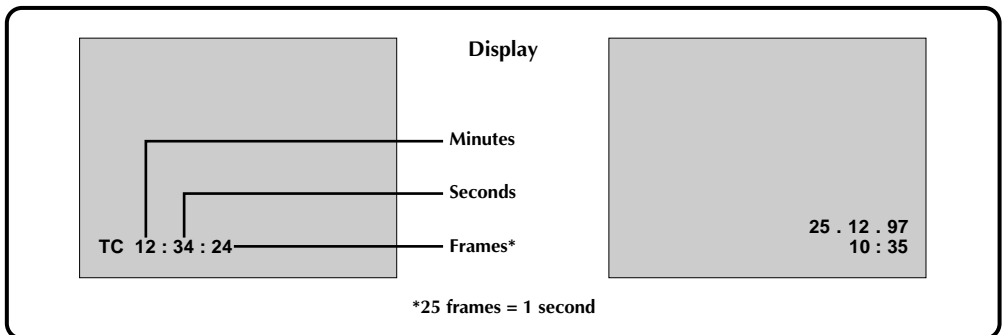

### TIME CODE (Displaying The Time Code During Playback)

You can display the Time Code on screen during playback. This is especially useful for editing. This function is preset to "OFF". To turn it on, select "TIME CODE" at the Playback Menu and change the setting (⏏ pg. 52).

**ON**– The Time Code is displayed on the playback screen.

**OFF**– The Time Code does not appear.

### DISPLAY (Displaying the Date During Playback)

If the time has been set, the date is automatically recorded separately from the recorded video signal. You can display or remove the date anytime during playback. This function is preset to "ON". To turn it off, select "DISPLAY" at the Playback Menu and change the setting (⏏ pg. 52).

**ON**– The date is displayed on the playback screen.

**OFF**– The date is not displayed.

## VCR/TV Connection (when connecting directly to the camcorder)

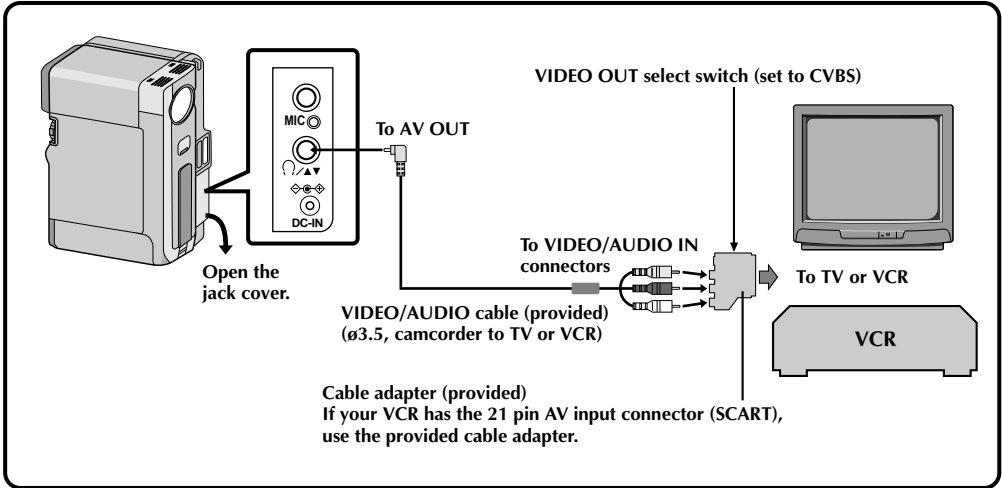
**1 CONNECT CAMCORDER TO TV OR VCR**

Pull out the jack cover and open it. Connect as shown in the illustration.

*If Using A VCR . . . go to step 2.  
If not . . . go to step 3.*

**2 CONNECT VCR OUTPUT TO TV INPUT**

Refer to your VCR's instruction manual.

**3 TURN ON POWER**

Turn the Power Dial to "PLAY" and turn on the TV/VCR.

**4 SELECT TV'S VIDEO MODE**

Set the TV to the channel or mode appropriate for video playback.

*To choose whether or not the following displays appear on the connected TV . . .*

- Date/Time, Time Code  
.... set to "ON" or "OFF" in the Playback Menu (☞ pg. 52).
- Playback Sound Mode Display  
.... Set the Power Dial to "M", press the MENU button, and set "ON SCREEN" in the Date/Time Menu (☞ pg. 11) to "ON" or "OFF". Then set the Power Dial back to "PLAY".

**NOTES:**

- Turn on the TV/VCR after connection is completed. Otherwise damage to this unit and other equipment may result.
- Input mode setting varies depending on the type of TV used. Refer to your TV's instruction manual.
- Make sure you adjust the TV sound volume to its minimum level to avoid a sudden burst of sound when the camcorder is turned on.
- To keep the camcorder's display from appearing on the TV screen during playback, press the IND.ON/OFF button for longer than 1 second.
- It is recommended to use the AC Power Adapter/Charger as the power supply instead of the battery pack. (☞ pg. 10)
- Never connect any other cable than the provided VIDEO/AUDIO cable to the camcorder's AV OUT jack.
- While the VIDEO/AUDIO cable is connected to the AV OUT jack, sound cannot be heard from the speaker.

## VCR/TV Connection (using Docking Station)

When you attach your camcorder to the Docking Station, you can add many interesting effects during playback.

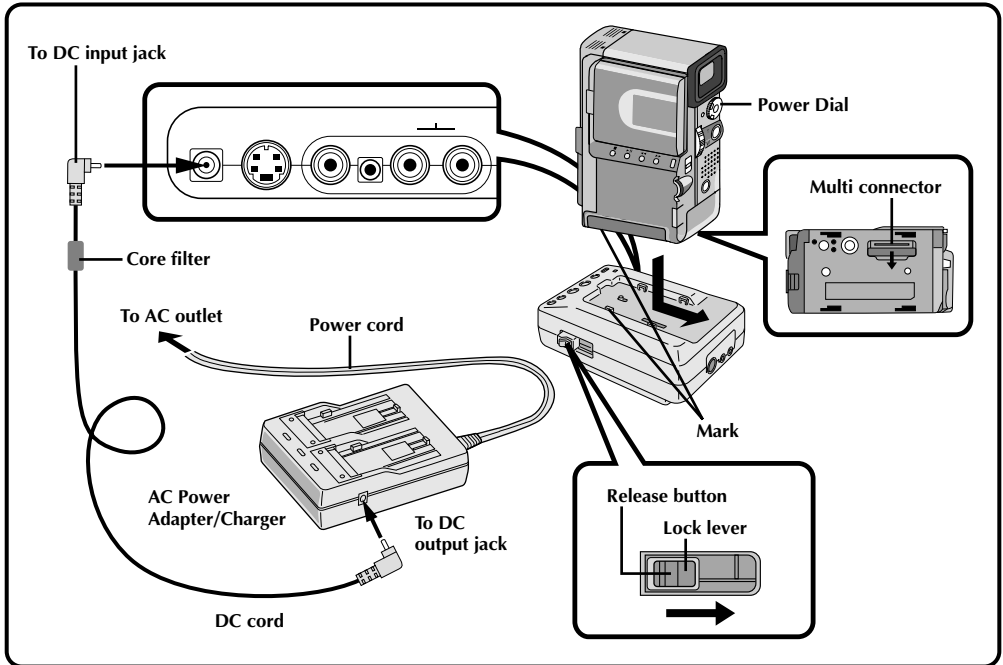

### 1 CONFIRM POWER-OFF STATUS

Make sure the camcorder's power is off.

### 2 ATTACH AND LOCKS

First open the Multi connector cover (MULTI) on the bottom of the camcorder. Align the mark on the camcorder with the one on the Docking Station and slide the camcorder in the direction of the arrow. Slide the lock lever on the Docking Station in the direction of the arrow until it clicks. The camcorder and the Docking Station are now securely attached.

- When removing the camcorder, press the Release button and slide the lock lever in the opposite direction of the arrow and detach the camcorder in the opposite direction of the arrow.

### 3 SUPPLY POWER

The Docking Station must be powered by the AC adapter whether the battery is in the camcorder or not.

- The Docking Station cannot function using the camcorder's battery.

## NOTES:

- When using the provided DC cord, make sure you connect the end of the cable with the core filter to the Docking Station. The core filter improves performance of equipment.
- Never touch the Multi connector on the camcorder located beneath the cover, or on the Docking Station, with your hand. If the pins are damaged, the connectors will become unusable due to contact failure.

## Charging The Camcorder Battery

If you attach the camcorder with the battery installed to the Docking Station, you can charge the battery. Set the Power Dial to "OFF", then perform steps 1 through 3. The Docking Station's charger indicator starts blinking to indicate that charging has begun. When it stops blinking but stays on, charging is complete.

## CHARGING TIME

BATT. PACK	CHARGE
BN-V907U	approx. 2 hours

- Do not attach or remove the battery while the camcorder is attached to the Docking Station.

CONTINUED ON NEXT PAGE

**VCR/TV connection (using the Docking Station) (Cont.)**

Please refer to your VCR and/or TV instruction manual(s) when connecting.

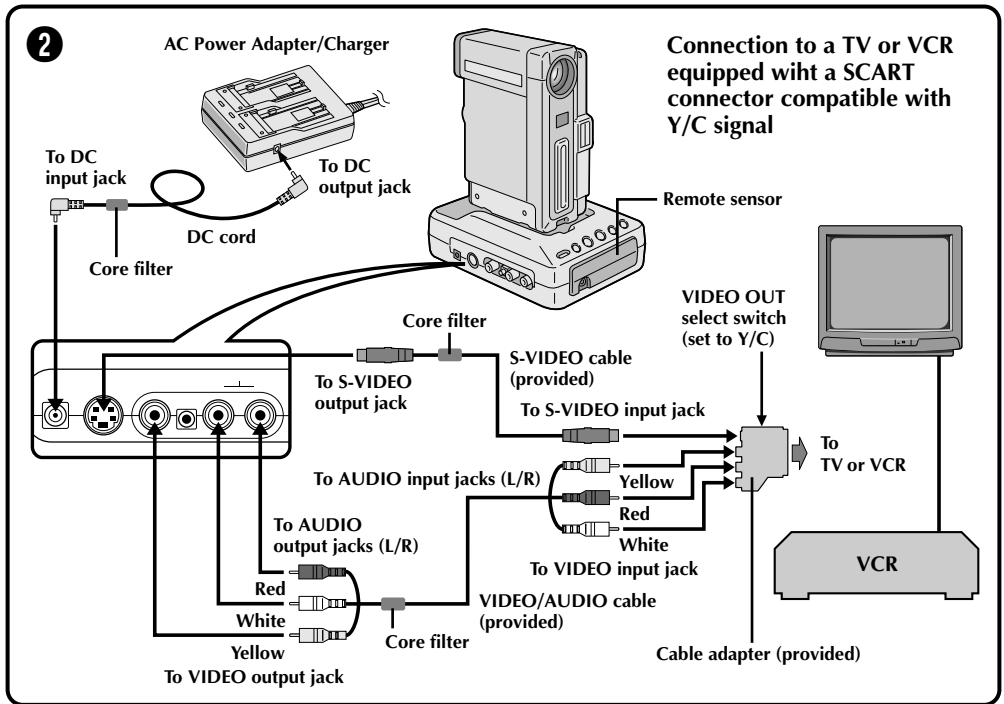
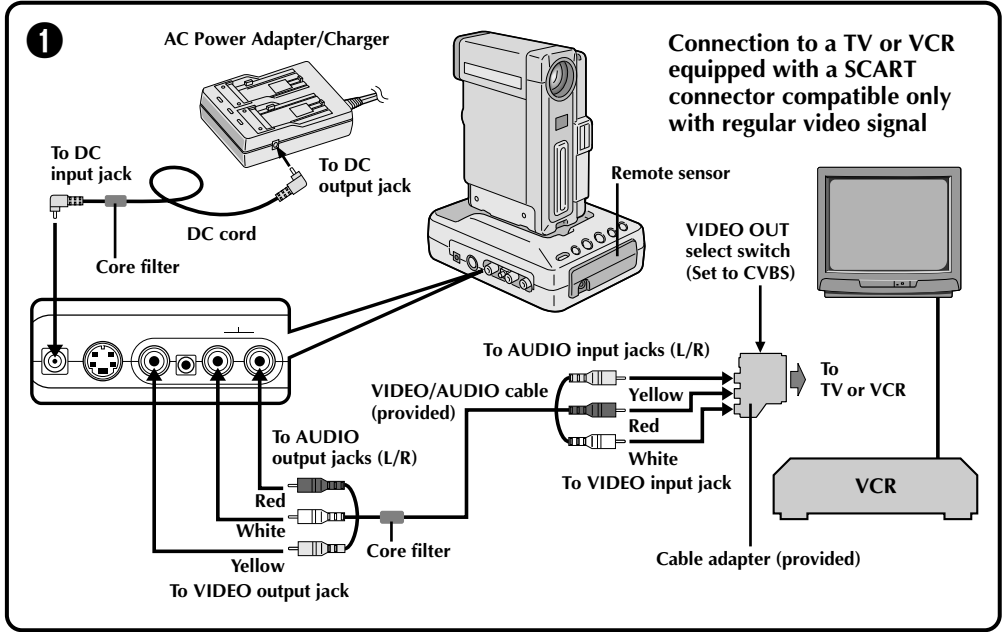



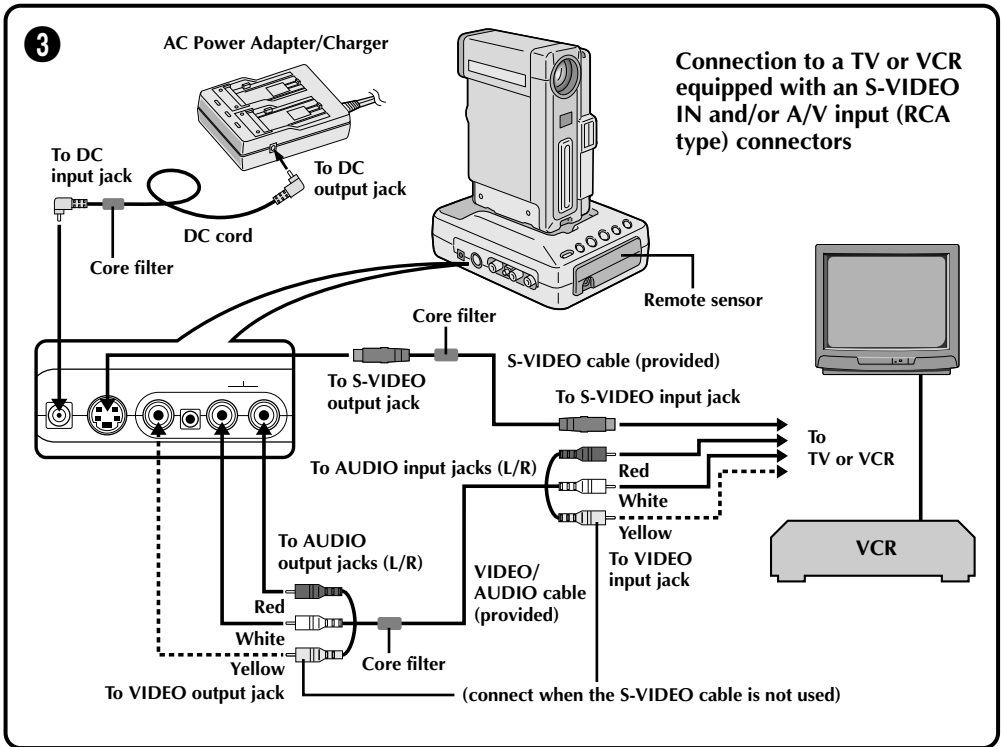

Connection to a TV or VCR equipped with an S-VIDEO IN and/or A/V input (RCA type) connectors

## 1 CONNECT DOCKING STATION TO TV OR VCR

Connect as shown in the illustration ①, ② or ③ (☞ pg. 56, 57).

If Using A VCR . . . go to step 2.  
If not . . . go to step 3.

## 2 CONNECT VCR OUTPUT TO TV INPUT

Refer to your VCR's instruction manual.

## 3 TURN ON POWER

## 4 SELECT TV'S VIDEO MODE

Set the TV to the channel or mode appropriate for video playback.

## NOTES:

- When using the provided VIDEO/AUDIO cable (Docking Station to TV or VCR), DC cord, S-VIDEO cable or editing cable, make sure you connect the end of the cable with the core filter to the Docking Station. The core filter improves performance of equipment.
- If TV/VCR is equipped with only one audio connector, use a conversion plug (commercially available).
- Set the VIDEO OUT select switch of the cable adapter as required:  
Y/C: When connecting to a TV or VCR which accepts Y/C signals and uses an S-VIDEO cable.  
CVBS: When connecting to a TV or VCR which does not accept Y/C signals and uses an audio/video cable.
- To turn off the speaker's sound, ☞ pg. 49.

## Using the remote control unit with the camcorder attached to the Docking Station

While the camcorder is attached to the Docking Station, the camcorder's remote sensor does not function. Point the remote control at the sensor located on the Docking Station.

## Dubbing

You can copy recorded scenes from the camcorder onto a videotape. Refer to your VCR's instruction manual for details.

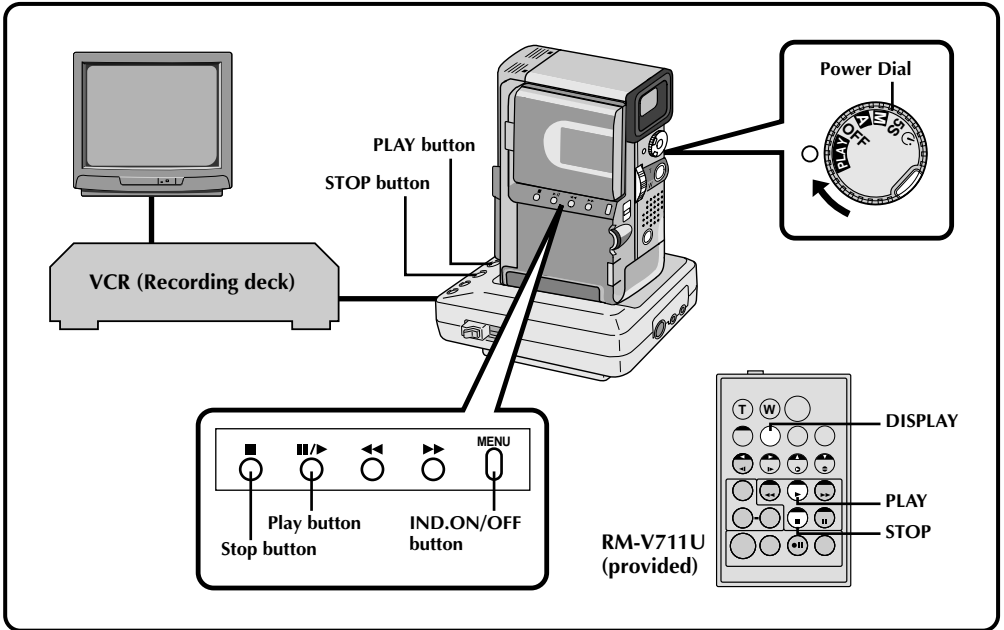

### 1 MAKE CONNECTIONS

Connect the Docking Station to your VCR as shown in the illustration on pages 56, 57. Please also refer to your VCR's instruction manual before dubbing.

### 2 START PLAYBACK

Press the Play button (▶) to play back the source tape.

### 3 START RECORDING

While watching on the connected TV, engage your VCR's record mode from the spot on the source tape you want to begin recording.

### 4 PAUSE RECORDING

Engage your VCR's pause mode to stop recording a segment.

### 5 END RECORDING

Press the Stop button (■) to stop the source tape, and engage the VCR's stop mode.

### NOTES:

- You can use Playback Zoom (☞ pg. 50) or Playback Effects (☞ pg. 51) in step 2.
- Before you start dubbing, make sure that the indications do not appear on the connected TV. If they do appear during dubbing, they are being recorded onto the new tape.  
To clear the Playback Sound Mode Display, press **DISPLAY** on the RM-V711U Remote Control.
- Select "DISPLAY" and "TIME CODE" from the Playback Menu (☞ pg. 52) to show or hide the Date/Time and the Time Code on the recording.
- To show or hide all indications, press the **IND.ON/OFF** button on the camcorder for longer than 1 second.

## Brand Setting

Before you can perform Random Assemble Editing (☞ pg. 60), or control the VCR using the RM-V711U remote control, you must set the VCR brand.

### SET REMOTE/VCR CODE

Before operation, make sure the lithium battery is installed in the remote control RM-V711U (☞ pg. 17).

#### 1 SET REMOTE TO OPERATE VCR

Turn off the power to the VCR and point the remote towards the VCR's infrared sensor. Then, referring to the VCR CODE LIST on the left, press and hold **MBR SET**, and press button (A) and then (B).

- The code is automatically set once you release the **MBR SET** button, and the VCR's power comes on.

#### 2 OPERATE THE VCR

Make sure the VCR's power is on. Then, while holding **SHIFT**, press the button on the remote for the desired function. The functions the remote can control are PLAY, STOP, PAUSE, FF, REW and VCR REC STBY (you don't need to press **SHIFT** for this one).

*You're now ready to try Random Assemble Editing.*

## IMPORTANT

Although the MBR is compatible with JVC VCRs and those of many other makers, it may not work with yours or may offer limited functions.

## NOTES:

- If the VCR's power doesn't come on in step 1, try another code from the VCR CODE LIST.
- Some brands of VCR don't come on automatically. In this case, turn the power on manually and try step 2.
- If the RM-V711U is not able to control the VCR, use the controls on the VCR.
- When the remote control's battery runs out, the VCR brand you have set will be erased. In that case, replace the old battery with a new one to reset the VCR brand.

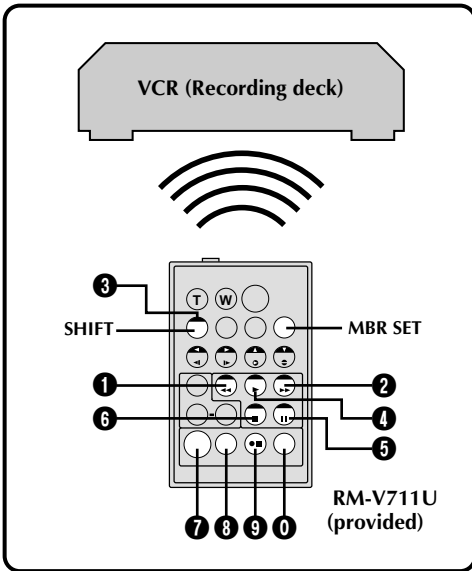

### VCR CODE LIST

VCR BRAND NAME	BUTTONS (A) (B)	VCR BRAND NAME	BUTTONS (A) (B)
AKAI	6 2 6 4 7 7	PHILIPS	1 9 9 5 1 1 9 4 9 1 9 6 1 2 3 3
BLAUPUNKT	1 3	SANYO	3 6 3 5
FERGUSON	9 7 9 8 3 2	SELECO, REX	9 1 9 6
GRUNDIG	1 4 3 4	SHARP	1 5 1 0
HITACHI	6 6 6 3	SONY	6 5 6 0 3 9 3 1
JVC A B C	9 1 9 6 9 3	THOMSON, TELEFUNKEN, SABA, NORDMENDE	9 1 9 6 9 7 3 2
MITSUBISHI	6 7 6 8	TOSHIBA	6 9 6 1
NEC	3 7 3 8		
PANASONIC	1 3 1 7 1 1 9 4 1 8		

## Random Assemble Editing

Using the RM-V711U remote control, you can use P.AE/Effects and make an original edited tape.

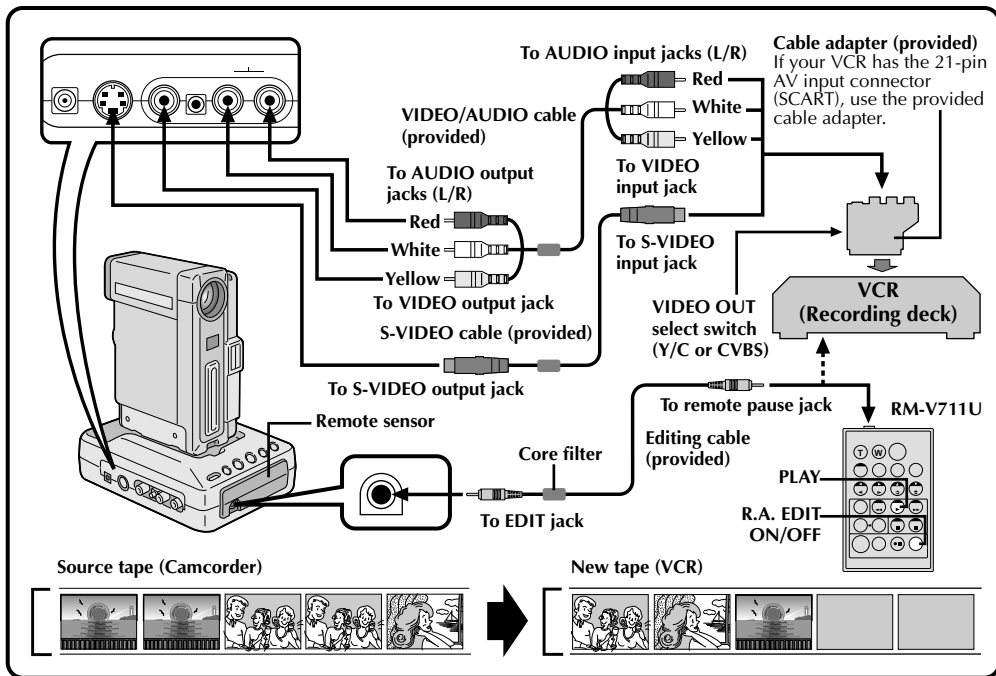

### 1 MAKE CONNECTIONS

Connect the Docking Station to your VCR and make sure that the playback picture and sound are available on the connected TV (☞ pg. 56, 57).

- Connections should be made while the power is off. Making connections with the power on can lead to electrical shock or malfunctions.

### 2 START SOURCE PLAYBACK

First turn the Power Dial to "PLAY". Press **PLAY** and then press **R.A. EDIT ON/OFF** on the remote control. Make sure to point the remote control at the Docking Station's remote sensor.

- The Random Assemble Editing Menu appears on the TV screen or the LCD monitor.

### 3 EXECUTE FADE/WIPE IN (IF NECESSARY)

Press **FADE/WIPE** on the remote control.

- Cycle through the effects by pressing repeatedly, and stop when the one you want is displayed.
- You can't use a Picture Wipe/Dissolve at the beginning of Program 1.

### NOTES:

- When using a JVC VCR with a remote pause terminal, connect the editing jack on the Docking Station to the VCR's remote pause terminal using an editing cable.
- If you use a JVC VCR not equipped with a remote pause terminal or a non-JVC VCR, connect the Docking Station's editing jack to the remote control's remote pause terminal using an editing cable.
- Set the VIDEO OUT select switch of the cable adapter as required:  
Y/C: When connecting to a TV or VCR which accepts Y/C signals and uses an S-VIDEO cable.  
CVBS: When connecting to a TV or VCR which does not accept Y/C signals and uses an audio/video cable.
- Before Random Assemble Editing, make sure the indications don't appear on the TV monitor. If they appear during Random Assemble Editing, they will be recorded onto the new tape. To clear the Playback Sound Mode Display, press **DISPLAY** on the RM-V711U Remote Control. Select "DISPLAY" and "TIME CODE" from the Playback Menu (☞ pg. 52) to show or hide the Date/Time and the Time Code on the recording. To show or hide all indications except for the Random Assemble Editing Menu, press the **IND.ON/OFF** button on the camcorder for longer than 1 second. When Random Assemble Editing starts, its indications disappear and are not recorded on the new tape.

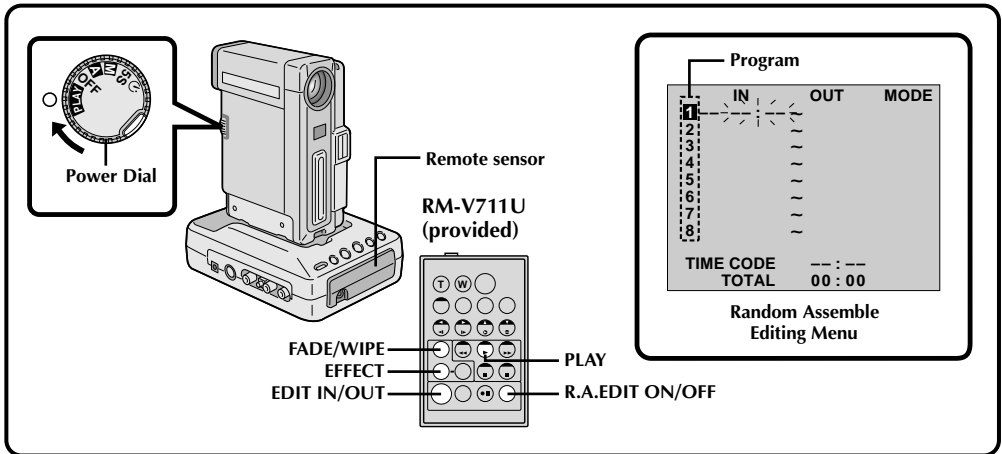

#### 4 SET EDIT-IN POINT

At the beginning of the scene, press **EDIT IN/OUT** on the remote control. The Edit-In position appears on the Random Assemble Editing Menu.

#### 5 SET EDIT-OUT POINT

At the end of the scene, press **EDIT IN/OUT**. The Edit-Out position appears on the Random Assemble Editing Menu.

#### 6 USE FADE WIPE ON SCENE TRANSITION (IF NECESSARY)

Press **FADE/WIPE**.

- Cycle through the effects by pressing repeatedly, and stop when the one you want is displayed.
- If you select a Fade/Wipe effect for an Edit-Out point, the effect is automatically applied to the following Edit-In point.
- You can't use a Picture Wipe/Dissolve at the end of the last scene.
- When you use Fade/Wipe effects, that time is included in the total time (this does not apply to Picture Wipe/Dissolve).

#### 7 USE P.AE/EFFECT (IF NECESSARY)

Press **EFFECT**.

- Cycle through the effects by pressing repeatedly, and stop when the one you want is displayed.
- You can use Classic Film, Monotone, Sepia, Strobe or Video Echo effects.
- If you're not using Fade/Wipe or P.AE/Effects, repeat steps 4 and 5 only.

#### NOTES:

- When the source tape has more than 2 identical time codes (see pg. 21), the camcorder may not find the Edit-In point you chose and a malfunction may occur.
- When choosing a scene, set Edit-In and Edit-Out points so there's a relatively large difference between them.
- If the search time for an in-point exceeds 5 minutes, the recording deck's Record-Standby mode will be cancelled and editing will not take place.
- If there are blank portions before or after the Edit-In and Edit-Out points, a blue-backed screen may be included in the edited version.
- Since time codes register time only as accurately as seconds, the time code total time may not match the total program time exactly.
- Turning off the camcorder's power erases all registered Edit-In and Edit-Out points.
- If you use Sepia or Monotone P.AE/Effects, you can't use the Dissolve or Black & White Fader. In this case the Dissolve or Black & White indicator begins blinking. Once the next Edit-In point is registered, the effect is turned off. To combine these effects, use Sepia or Monotone during recording, then use Dissolve or Black & White Fader during Random Assemble Editing.

CONTINUED ON NEXT PAGE

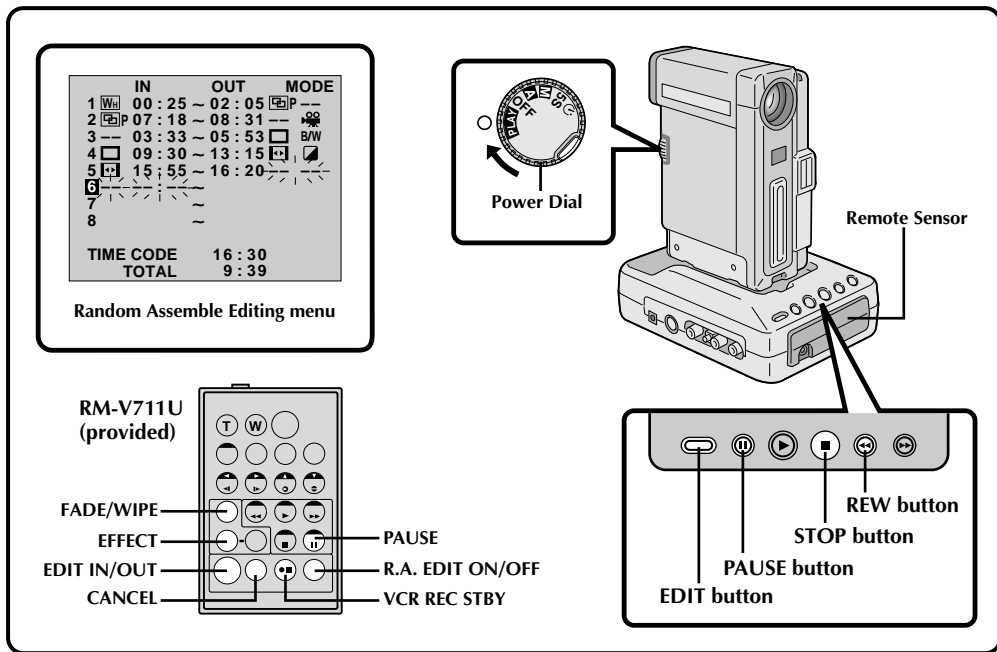

## 8 REGISTER ADDITIONAL SCENES

Repeat steps 4 – 7 (☞ pg. 61).

- To change previously registered points, press **CANCEL** on the remote control. The registered points disappear, one at a time, from the most recently registered point.

## 9 PREPARE SOURCE TAPE

Rewind the tape in the camcorder to the beginning of the scene you want to edit and press the Pause button (II).

## 10 ENGAGE VCR'S RECORD-PAUSE MODE

Point the remote control towards the VCR's remote sensor and press **VCR REC STBY**, or manually engage the VCR's Record-Pause mode.

## NOTES:

- When the editing cable is connected to the Pause terminal during dubbing, make sure the remote control is pointed at the recorder's sensor, and that the path between the two is unobstructed.
- If, during Random Assemble Editing, you press any button on the camcorder, its Record-Standby mode is automatically engaged.
- Random Assemble Editing may not function properly when using a tape including several duplicated Time Codes. (☞ pg. 21).

## 11 START EDITING

Press the **EDIT** button on the Docking Station. Editing proceeds as programmed, right through to the end of the last registered scene.

- When dubbing is complete, the camcorder enters the Pause mode, and the recorder enters its Record-Standby mode.
- If you don't register an Edit-Out point, the tape will be dubbed all the way to the end automatically.

## 12 STOP EDITING

Engage the Stop modes for the camcorder and the recorder.

To make the R.A. Edit counter display disappear, press **R.A. EDIT ON/OFF** on the remote control.

## For More Accurate Editing

Some VCRs make the transition from Record-Standby to Record mode faster than others. Even if you begin editing for the camcorder and the VCR at exactly the same time, you may lose scenes you wanted, or find that you've recorded scenes you didn't want. For a cleanly edited tape, confirm and adjust the timing of the camcorder against your VCR.

### Diagnosing VCR's against Camcorder Timing

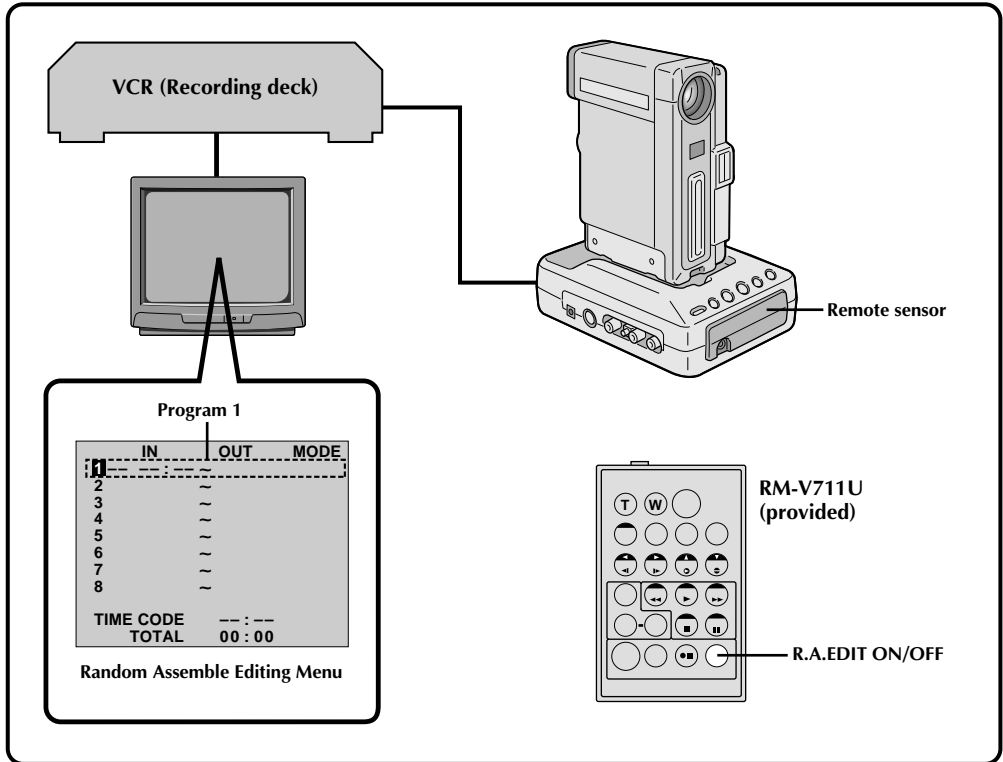

### 1 PREPARE FOR R.A. EDIT

Play back the tape in the camcorder, then point the remote control at the Docking Station's remote sensor and press **R.A. EDIT ON/OFF**.

- "Random Assemble Editing Menu" appears on the TV screen.

### 2 CHOOSE A SCENE

Perform Random Assemble Editing on Program 1 only. In order to check VCR and camcorder timing, select the beginning of a scene transition as your Edit-In point.

### 3 PLAY BACK DUBBED SCENE

- If any images from the scene prior to the transition you chose for your Edit-In point were recorded, that means your VCR moves quickly from Record-Pause to Record mode.
- If the scene you tried to dub starts in progress, the VCR is slow to start recording.

CONTINUED ON NEXT PAGE

## Adjustment of VCR's against Camcorder Timing

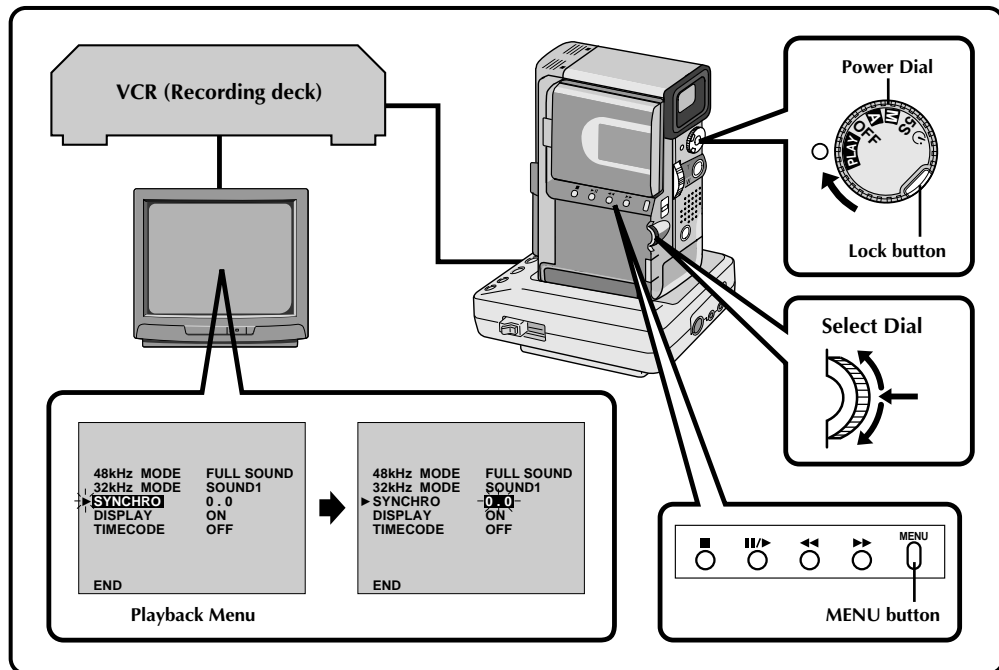
**4 ACCESS PLAYBACK MENU**

Point the remote control at the Docking Station's remote sensor and press R.A. EDIT ON/OFF to make the Random Assemble Editing menu disappear, then press **MENU**. The Playback Menu appears on the TV screen.

**5 SELECT FUNCTION**

Move the pointer and highlight bar to "SYNCHRO" by rotating the Select Dial, then press it. The value for "SYNCHRO" is highlighted.

**6 INPUT CORRECTION DATA**

Based on the diagnostics performed (see pg. 63), you can now increase the VCR's speed by rotating the Select Dial upward. You can also slow down the VCR's speed by rotating the Select Dial downward. The adjustment range is from -1.3 to +1.3 seconds, in 0.1-second increments.

**7 CLOSE MENU**

Press the Select Dial twice.

- Now perform Random Assemble Editing beginning with step 2 on page 60.

**NOTES:**

- Before performing actual Random Assemble Editing, do a few Random Assemble Editing trial runs to check whether the value you have input is appropriate or not, and make adjustments accordingly.
- Depending on the recorder, there may be situations where the timing difference cannot be fully corrected.



## Audio Dubbing

The audio track can be customized only when recorded on the 32 kHz mode (▶ pg. 35).

### NOTE:

Audio Dubbing is not possible on a tape recorded at 48 kHz, on a tape recorded in the LP mode or on a blank portion of a tape.

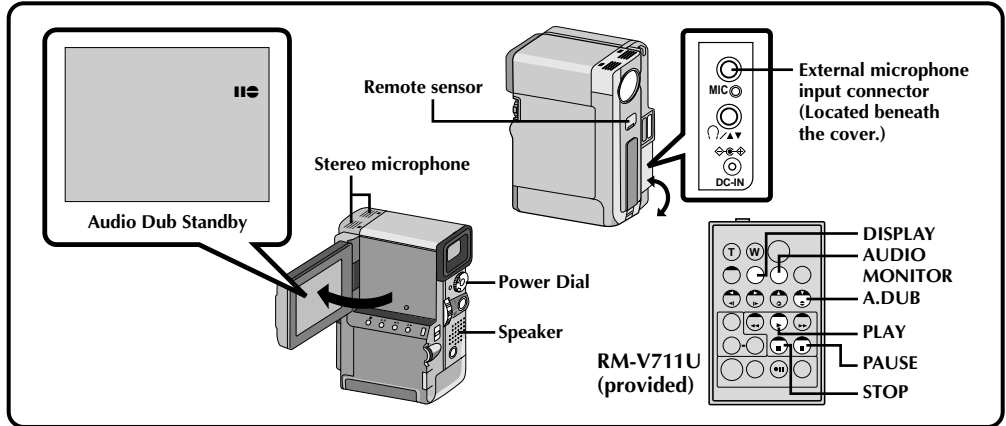

- 1 FIND EDIT-IN POINT**  
Play back the tape to locate the point where editing will start, then press **PAUSE**.
- 2 ENGAGE AUDIO DUB STANDBY**  
While holding **A. DUB** on the remote control, press **PAUSE**. "II" appears.

- 3 BEGIN DUBBING**  
Press **PLAY**, then begin "narrating".  
• Speak into the microphone.

- 4 PAUSE DURING DUBBING**  
Press **PAUSE**.

- 5 STOP DUBBING**  
Press **STOP**.

### NOTES:

- Audio dubbing is possible using an optional microphone connected to the external microphone input connector (MIC).
- While an optional microphone is connected, the built-in microphone is disabled.
- When editing onto a tape that was recorded at 32 kHz, the old and new soundtracks are recorded separately.
- To select the desired sound for playback, press **AUDIO MONITOR** on the remote control.
- If you dub onto a blank space on the tape, the sound may be disrupted. Make sure you only edit recorded areas.
- If feedback or howling occurs during TV Playback, move the camcorder's microphone away from the TV, or turn down the TV's volume.
- Sound is not heard from the speaker during Audio Dubbing. To hear sound, connect optional headphones to the AV-OUT (headphones) jack.
- If you change from 32 kHz to 48 kHz in mid-recording and then use the tape for Audio Dubbing, it is not effective from the point where 48 kHz recording began.
- During Audio Dubbing, when the tape moves to scenes recorded in the LP mode, scenes recorded at 48 kHz or a blank portion, Audio Dubbing stops and "ERROR! REFER MANUAL" appears.

RECORDING SOUND	DISPLAY	OUTPUT SOUND
32 kHz	FULL SOUND	Original and new tracks are combined and output in stereo.
	SOUND 2	New track is output on both "L" and "R" channels in stereo.
	SOUND 1	Original track is output on both "L" and "R" channels in stereo.

## Insert Editing

You can record a new scene into a previously recorded tape, replacing a section of the original recording with minimal picture distortion at the in- and out-points. The original audio remains unchanged.

### NOTE:

*Insert Editing is not possible on a tape recorded in the LP mode or on a blank portion of a tape.*

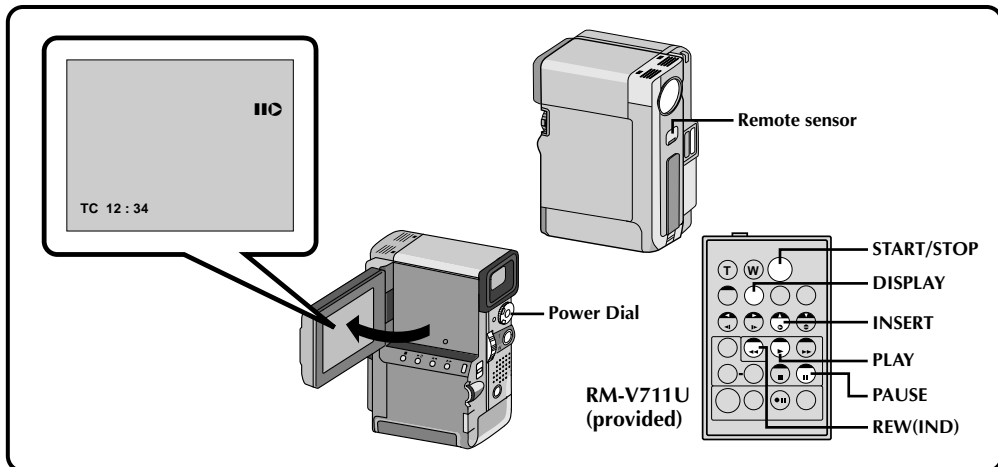

### 1 FIND EDIT OUT POINT

Playback the tape to locate the point where you want to stop editing. Confirm the time code at this point (☞ pg. 53).

### 2 FIND EDIT IN POINT

Press **REW** until the point is located, then press **PAUSE**.

### 3 PREPARE FOR INSERT EDITING

Press and hold **INSERT** on the remote control, then press **PAUSE**. "HC" and the Time Code (min.:sec.) appear and the camcorder enters Insert-Pause mode.

### 4 START RECORDING

Press **START/STOP** to begin editing.

- Confirm the insert at the time code you checked in step 1.

### 5 PAUSE DURING EDITING

Press **START/STOP**. The camcorder re-enters Insert Pause mode. Press again to resume editing.

### 6 STOP EDITING

Press **STOP** while the camcorder is in the Insert-Pause mode.

### NOTES:

- *P.AE/Effects* (☞ pg. 42) can be used to spice up the scenes being edited during Insert Editing.
- To display the Time Code during Insert Editing, ☞ pg. 52.
- When performing Insert Editing, the tape's Video Area and Sub-Code Area (☞ pg. 6) are rewritten, so the date and time information changes.
- If you perform Insert Editing onto a blank space on the tape, the audio and video may be disrupted. Make sure you only edit recorded areas.
- During Insert Editing, when the tape moves to scenes recorded in the LP mode or a blank portion, Insert Editing stops and "ERROR! REFER MANUAL" appears.

If, after following the steps in the chart below, the problem still exists, please consult your nearest JVC dealer.

SYMPTOM	POSSIBLE CAUSES	CORRECTIVE ACTION
<p>1. No power is supplied.</p>	<p>1. • The power is not connected properly. • The battery is dead. • The LCD monitor is not open fully or the viewfinder is not pulled out when recording.</p>	<p>1. • Connect the AC Adapter securely (☞ pg. 10). • Replace the dead battery with a fully charged one (☞ pg. 9). • Open the LCD monitor fully or pull out the viewfinder. The LCD monitor turns on/off when it is opened/closed at approx. 90° while the Power Dial is set to any position except "OFF" if the viewfinder is not fully pulled out.</p>
<p>2. Recording cannot be performed.</p>	<p>2. • The tape's record safety tab is set to "SAVE". • The Power Dial is set to "PLAY". • "TAPE END" appears. • The cassette's cover is open.</p>	<p>2. • Set the tape's record safety tab to "REC" (☞ pg. 12). • Set the Power Dial to "A", "M", "5S" or "S" (☞ pg. 18). • Replace with new cassette (☞ pg. 12). • Close the cassette's cover.</p>
<p>3. There is no playback picture.</p>	<p>3. • The camcorder is not getting power, or some other malfunction exists.</p>	<p>3. • Turn the camcorder's power off and on again (☞ pg. 19).</p>
<p>4. Some functions are not available using the MENU button.</p>	<p>4. • The Power Dial is set to "A".</p>	<p>4. • Set the Power Dial to any position except "A" (☞ pg. 18).</p>
<p>5. Some functions are not available using the Select Dial.</p>	<p>5. • The Power Dial is set to "5S" and "A".</p>	<p>5. • Set the Power Dial to any position except "5S" and "A" (☞ pg. 18).</p>
<p>6. The focus does not adjust automatically.</p>	<p>6. • Focus is set to "MANUAL". • The recording was done in a dark place, or the contrast was low. • The lens is dirty or covered with condensation.</p>	<p>6. • Set Focus to "AUTO" (☞ pg. 44). • Clean the lens and check the focus again (☞ pg. 72).</p>
<p>7. The cassette won't load properly.</p>	<p>7. • The cassette is in the wrong position. • The battery's charge is low.</p>	<p>7. • Set it in the right position (☞ pg. 12). • Install a fully charged battery (☞ pg. 8).</p>
<p>8. Play, Rewind and Fast-Forward functions don't work.</p>	<p>8. • The Power Dial is not set to "PLAY".</p>	<p>8. • Set the Power Dial to "PLAY" (☞ pg. 49).</p>
<p>9. The tape is moving, but there's no picture.</p>	<p>9. • Your TV has AV input terminals, but is not set to its VIDEO mode. • The cassette's cover is open.</p>	<p>9. • Set the TV to the mode or channel appropriate for video playback (☞ pg. 56, 57). • Close the cassette's cover (☞ pg. 12).</p>
<p>10. In the 5-Second mode, recording ends before 5 seconds have elapsed.</p>	<p>10. • The 5-Second mode in the System Menu is set to "ANIM."</p>	<p>10. • Select "5S" or "5SD" in the System Menu (☞ pg. 35).</p>

SYMPTOM	POSSIBLE CAUSES	CORRECTIVE ACTION
11. Even though "GAIN UP" was set to "A35", scenes shot in dark places are not brightened.	11. • Depending on the light source, the 1/25 shutter speed may be deactivated in order to reduce the shakiness in the picture.	11. _____
12. Snapshot mode cannot be used.	12. • The Squeeze mode is selected.	12. • Disengage the Squeeze mode (☞ pg. 31).
13. Although the SNAPSHOT button is pressed, the white border does not appear.	13. • "PHOTO FRAME" is set to "OFF" in the system menu. • The Cinema mode is engaged, disabling the white border.	13. • Set "PHOTO FRAME" to "ON" in the system menu (☞ pg. 35). • Disengage the Cinema mode (☞ pg. 31).
14. Digital Zoom doesn't work.	14. • 10X optical zoom is selected. • The Video Echo effect is activated. • Picture Wipe or Dissolve are being used in a scene transition. • 5-Second recording was done with the Power Dial set to "5S", and with "5SD" selected in the System Menu. • Snapshot Dissolve was attempted during Digital Zoom.	14. • Turn off the Video Echo effect (☞ pg. 43). • Wait until the Picture Wipe or Dissolve effects are completed (☞ pg. 38). • Change the setting of either the System Menu or the Power Dial (☞ pg. 34). • Do not attempt to take a Snapshot when performing Digital Zoom (☞ pg. 25).
15. P.AE/Effects and Fade/Wipe Effects don't work.	15. • The Power Dial is set to "A". • The Power Dial is set to "5S".	15. • Set the Power Dial to "M" (☞ pg. 18). • Change the setting of the Power Dial.
16. The Black & White Fader doesn't work.	16. • The Sepia or Monotone effects are activated.	16. • Turn off Sepia and Monotone (☞ pg. 42).
17. The Dissolve function doesn't work.	17. • P.AE/Effects Sepia, Monotone or Slow are activated. • The Squeeze mode is selected. • The previously selected P.AE/Effect was changed after the last selected scene for editing was registered.	17. • Turn off Sepia and Monotone before adding Dissolve to a scene transition (☞ pg. 42). • Make sure that the Squeeze mode in the Recording Menu is set to "OFF" (☞ pg. 30). • Make sure you have selected the P.AE/Effects you want before starting editing (☞ pg. 42).
18. Scene transition does not go as expected.	18. • When using "Picture Wipe/Dissolve" (☞ pg. 38) or "Dissolves during 5 second mode recording" (☞ pg. 28), there is a delay of a fraction of a second between the previous record stop-point and the Dissolve start-point. This is normal, but this slight delay becomes especially noticeable when shooting fast-moving subject or during rapid panning.	18. _____

SYMPTOM	POSSIBLE CAUSES	CORRECTIVE ACTION
<p><b>19.</b> The Picture Wipe and Dissolve functions don't work.</p>	<p><b>19.</b></p> <ul style="list-style-type: none"> <li>• The last selected editing scene is ending.</li> <li>• At the end of the last selected scene for editing, the Power Dial was set to "OFF".</li> <li>• The power is off.</li> </ul>	<p><b>19.</b></p> <ul style="list-style-type: none"> <li>• Select Picture Wipe or Dissolve before beginning recording. The effects are then automatically activated (☞ pg. 38).</li> <li>• Do not turn off the camcorder's power after setting Edit-In and Edit-Out points, as they will all be erased (☞ pg. 38).</li> <li>• The camcorder automatically shuts off after 5 minutes have elapsed in the Record-Standby mode. Make sure you continue operations within 5 minutes after engaging Record-Standby mode (☞ pg. 38).</li> </ul>
<p><b>20.</b> The Picture Wipe function doesn't work.</p>	<p><b>20.</b></p> <ul style="list-style-type: none"> <li>• The Slow (Slow Shutter) effect is activated.</li> <li>• The Squeeze or Cinema mode is selected in the Recording Menu.</li> </ul>	<p><b>20.</b></p> <ul style="list-style-type: none"> <li>• Make sure the Squeeze mode, Cinema mode, or Slow effect is not activated when preparing to use the Picture Wipe function (☞ pg. 31, 43).</li> </ul>
<p><b>21.</b> Even when Slow (Slow Shutter) isn't selected, the image looks like it is activated.</p>	<p><b>21.</b></p> <ul style="list-style-type: none"> <li>• When shooting in the dark with GAIN UP set to <b>A</b> , the unit becomes highly sensitive to light and the image takes on an effect similar to Slow (Slow Shutter).</li> </ul>	<p><b>21.</b></p> <ul style="list-style-type: none"> <li>• If you want the lighting to look more natural, set GAIN UP to "AGC" or "OFF" in the Recording Menu (☞ pg. 32).</li> </ul>
<p><b>22.</b> The Video Echo effect doesn't work.</p>	<p><b>22.</b></p> <ul style="list-style-type: none"> <li>• The Picture Wipe or Dissolve functions are in use.</li> <li>• The Squeeze mode is selected in the Recording Menu.</li> <li>• Snapshot Dissolve is in progress.</li> <li>• A Fade-In or Fade-Out is in progress (White Fader, Black Fader or Black &amp; White Fader).</li> </ul>	<p><b>22.</b></p> <ul style="list-style-type: none"> <li>• Make sure the Squeeze mode is set to "OFF" (☞ pg. 31).</li> <li>• Do not try to use the Video Echo effect during a Fade-In or Fade-Out (☞ pg. 36).</li> </ul>
<p><b>23.</b> There is no strobe when the Classic Film and Strobe effects are activated.</p>	<p><b>23.</b></p> <ul style="list-style-type: none"> <li>• The Picture Wipe or Dissolve functions are in use.</li> <li>• Snapshot Dissolve is in progress.</li> </ul>	<p><b>23.</b></p> <ul style="list-style-type: none"> <li>• Do not try to use the Classic Film or Strobe effects during a scene transition (☞ pg. 43).</li> </ul>
<p><b>24.</b> White Balance cannot be activated.</p>	<p><b>24.</b></p> <ul style="list-style-type: none"> <li>• The Sepia or Monotone effects are activated.</li> <li>• Snapshot Dissolve is in progress.</li> </ul>	<p><b>24.</b></p> <ul style="list-style-type: none"> <li>• Turn off Sepia or Monotone before setting White Balance (☞ pg. 42).</li> <li>• Wait until the Snapshot Dissolve is finished before setting White Balance (☞ pg. 25).</li> </ul>

SYMPTOM	POSSIBLE CAUSES	CORRECTIVE ACTION
25. When shooting a subject illuminated by bright light, vertical lines appear.	25. • This is a result of exceedingly high contrast, and is not a malfunction.	25. _____
26. There are disturbances in audio and video.	26. • If Audio Dubbing or Insert Editing have been performed repeatedly on the same portion of the tape, disturbance to the sound and picture may result.	26. • Use a new, or infrequently used, tape for Audio Dubbing and Insert Editing (☞ pg. 65, 66).
27. During recording, the date/time does not appear.	27. • “DISPLAY” is set to “OFF” in the Date/Time Menu. • Interface shooting is performed.	27. • Set “DISPLAY” to “ON” in the Date/Time Menu (☞ pg. 11). • During interface shooting, the date/time does not appear (☞ pg. 23). • Press the <b>IND. ON/OFF</b> button for longer than 1 second to make the indicators appear (☞ pg. 22).
28. The indicators and messages do not appear on screen.	28. • “ON SCREEN” is set to “OFF” in the Date/Time Menu.	28. • Set “ON SCREEN” to “ON” in the Date/Time Menu (☞ pg. 33). • Press the <b>IND. ON/OFF</b> button for longer than 1 second to make the indicators appear (☞ pg. 22).
29. The indicators do not appear on the LCD monitor or in the viewfinder.	29. • You have made the indicators disappear.	29. • Press the <b>IND. ON/OFF</b> button for longer than 1 second to make the indicators appear (☞ pg. 22).
30. Images on the LCD monitor appear dark or whitish.	30. • In places subject to low temperature, images become dark due to the characteristics of the LCD monitor. When this happens, the displayed colours differ from those that are actually recorded. This is not a defect of the camcorder. • When the LCD monitor's fluorescent light reaches the end of its service life, images on the LCD monitor become dark. Consult your nearest JVC dealer.	30. • Adjust the brightness and angle of the LCD monitor (☞ pg. 22, 23).
31. The rear of the LCD monitor is hot.	31. • The light used to illuminate the LCD monitor causes it to become hot.	31. • Close the LCD monitor to turn it off or set the Power Dial to “OFF”, and let the unit cool down (☞ pg. 19).
32. The indicators and the image colour on the LCD monitor are not clear.	32. • This may occur when the surface or the edge of the LCD monitor is pressed.	32. _____
33. Images on the LCD monitor are jittery.	33. The speaker volume is too great.	33. • Turn the speaker volume down (☞ pg. 49).
34. The LCD monitor and the lens have become dirty (ex. fingerprints).	34. _____	34. • Wipe them gently with soft cloth. Wiping strongly can cause damage.

SYMPTOM	POSSIBLE CAUSES	CORRECTIVE ACTION
35. The LCD monitor indications blink.	35. • Certain FADE/WIPE, P.AE/ Effects, DIS and other functions that cannot be used together are selected at the same time.	35. • Re-read the sections covering FADE/WIPE, P.AE/ Effects and DIS (☞ pgs. 32, 36 – 43).
36. Coloured bright spots appear all over the LCD monitor.	36. • The LCD monitor is made with high-precision technology. However, black spots or bright spots of light (red, green or blue) may appear constantly on the LCD monitor. These spots are not recorded on the tape. This is not due to any defect of the unit. (Effective dots: more than 99.99 %)	36. _____
37. The LCD monitor indications are distorted.	37. • During playback of the unrecorded portion, High-speed Search and still playback, LCD monitor indications appear distorted. This is not a defect.	37. _____
38. An unusual mark appears in the LCD monitor or the viewfinder.	38. _____	38. • Check the section of the manual that explains LCD monitor/viewfinder indications (☞ pgs. 73 – 78).
39. An error indication (E01 — E07) appears in the LCD monitor or the viewfinder.	39. • A malfunction of some kind has occurred. In this case the camcorder's functions become unusable.	39. • Remove the power supply (battery pack, etc.) and press RESET button, and wait a few minutes for the indication to clear. When it does, you can resume using the camcorder. If the indication remains, please consult your nearest JVC dealer.
40. The charge indicator on the AC Power Adapter/ Charger does not light.	40. • The temperature of the battery is extremely high/ low. • Charging is difficult in places subject to extremely high/low temperatures.	40. • To protect the battery, it is recommended to charge it in places with a temperature of 10°C to 30°C (☞ pg. 9).
41. The recording mode indicator "LP" blinks on the LCD monitor or the viewfinder.	41. • This occurs when recording in the LP mode is not available. After the indicator blinks, the recording mode switches to "SP" and recording goes on.	41. _____
42. Picture does not appear on the LCD monitor	42. • The viewfinder is pulled out. • The LCD monitor's brightness setting is too dark.	42. • Push the viewfinder back in. • Adjust the brightness of the LCD monitor (☞ pg. 22). • If the monitor is tilted upward 180 degrees, open the monitor fully (☞ pg. 23).

## Cleaning The Camcorder

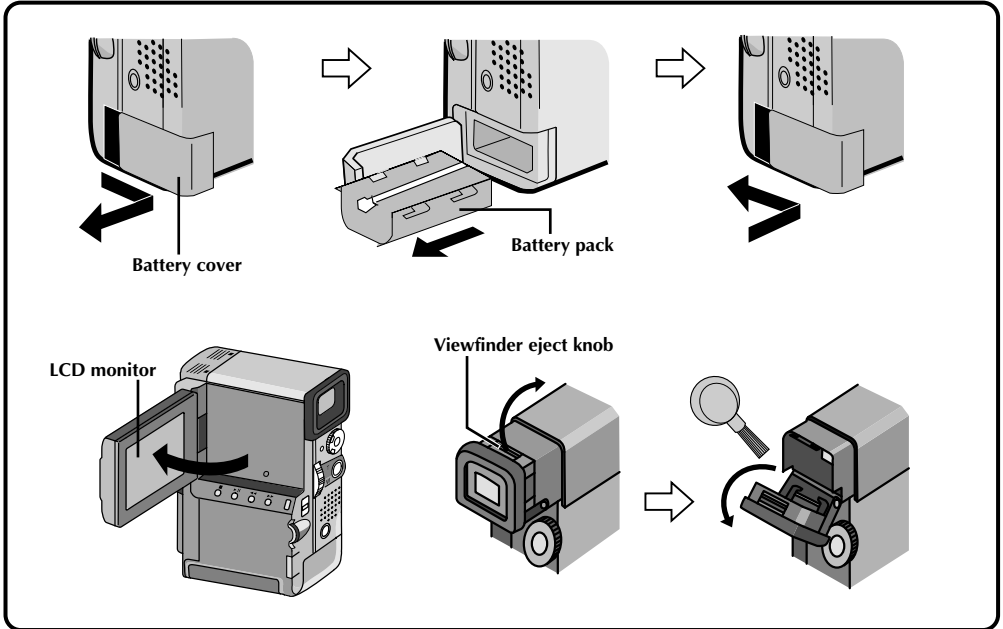

**1 REMOVE POWER SUPPLY**  
Remove the battery pack or disconnect the AC Power Adapter/Charger.

**2 CLEAN EXTERIOR**  
Wipe gently with a soft cloth.

- Put cloth in diluted mild soap and wring it well to wipe off heavy dirt. Then wipe again with a dry cloth.

**3 CLEAN LENS**  
Blow it with a blower brush, then wipe gently with lens cleaning paper.

**4 PULL OUT VIEWFINDER**  
Pull out the viewfinder fully.

**5 CLEAN VIEWFINDER**  
Use a small screwdriver to lift the viewfinder eject knob up and clean the viewfinder with a lens blower or a soft cloth.

**6 PUSH VIEWFINDER BACK IN**  
Return the viewfinder eject knob to its original position and push the viewfinder back in.

**7 OPEN LCD MONITOR**  
Open the LCD monitor fully.

**8 CLEAN LCD MONITOR**  
With soft cloth, gently wipe the LCD monitor in a semicircular pattern. Avoid using too much pressure as this will smear the monitor screen, making it much more difficult to clean.

**9 CLOSE LCD MONITOR**

**NOTES:**

- Avoid using strong cleaning agents such as benzine or alcohol. This may damage the unit's body or cause malfunction.
- When using a cleaner or chemically treated cloth refer to the cautions of each product.



## Camcorder

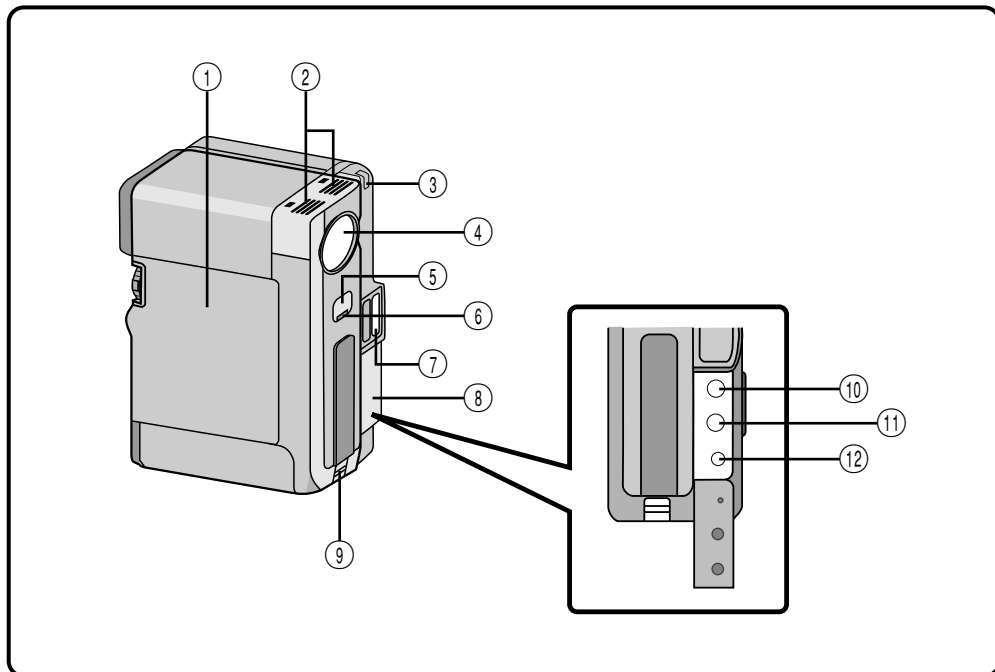

- ① **Cassette cover** (☞ pg. 12)  
Cassette is loaded inside the cover.
- ② **Stereo microphone** (☞ pg. 65)  
For use when recording or audio dubbing.
- ③ **White balance sensor**  
Adjusts the colour reproduction. Take care not to cover the sensor with your hand while shooting.
- ④ **Lens cover**  
Opens when the viewfinder is pulled out or the LCD monitor is opened fully.
- ⑤ **Remote sensor** (☞ pg. 50)  
Receives the signal from the remote control. When using the remote control, point it at the remote sensor.
- ⑥ **Tally lamp**  
Lights during recording.
- ⑦ **Flash (built-in sensor)** (☞ pg. 26)  
During Snapshot recording, this senses the brightness and flashes in a dark environments with insufficient light. Take care not to cover the sensor with your hand while shooting.
- ⑧ **Jack cover** (☞ pg. 54)  
Pull this out to detach.
- ⑨ **Hand strap eyelet** (☞ pg. 14)  
Slide the strap through the eyelet.
- ⑩ **External microphone input jack (MIC) (Stereo)** (☞ pg. 65)  
An optional microphone can be connected.
- ⑪ **Video/audio output jack or headphones jack (V/AV-OUT)** (☞ pg. 54, 65)  
The provided VIDEO/AUDIO cable (ø3.5) can be connected to a television etc. Using optional headphones, you can listen to the sound. However, headphones equipped with volume control cannot be used.
- ⑫ **DC input jack (DC-IN)** (☞ pg. 10)  
The DC cord of an AC Power Adapter or Power Pack can be connected.

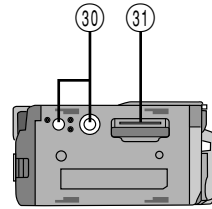
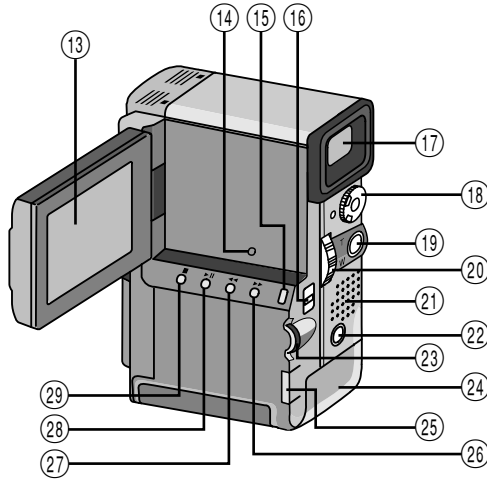

Bottom of the camcorder

- 13 LCD monitor** (☞ pg. 23)  
The image appears during recording or playback.
- 14 RESET button** (☞ pg. 71)  
When a malfunction occurs, press this button after removing the power supply (battery etc.). Pressing this button also resets the date/time or various settings.
- 15 MENU button** (☞ pg. 30)  
Press this button to make the Menu appear.  
**IND.ON/OFF button** (☞ pg. 22)  
Press and hold this button for more than approx. 1 second to make the indications appear on the LCD monitor or the viewfinder.
- 16 OPEN/EJECT switch** (☞ pg. 12)  
Slide the switch down when loading/unloading a tape.
- 17 Viewfinder** (☞ pg. 16)  
Pull out when recording.
- 18 Power dial** (☞ pg. 19)  
Turning the camcorder on/off, recording or playback is possible.
- 19 START/STOP button** (☞ pg. 19)  
Starts recording or stops recording to make the camcorder enter the record-standby mode.
- 20 Zoom switch or volume switch (VOL.)** (☞ pg. 24, 49)  
Adjusts zoom during recording or the sound volume during playback.
- 21 Speaker** (☞ pg. 49)  
During playback, the sound can be heard.
- 22 SNAPSHOT button** (☞ pg. 25)  
Press this button to take a snapshot.
- 23 Function Navigator Dial (Select Dial)** (☞ pg. 22, 30)  
Adjusts the brightness of the LCD monitor or selects the Menu etc. Referred to in this manual as "Select Dial"
- 24 BATTERY cover** (☞ pg. 9)  
Slide and open the battery cover to insert the battery.
- 25 Sub hand strap eyelet** (☞ pg. 15)  
Attach the grip strap to this eyelet.
- 26 Fast-Forward button** (⏩) (☞ pg. 49)  
Fast-Forwards the tape.  
**Sub SNAPSHOT button** (☞ pg. 25)  
Press this button to take a snapshot.
- 27 Rewind button** (⏪) (☞ pg. 49)  
Rewinds the tape.
- 28 Play button** (⏮/▶) (☞ pg. 49)  
Plays back or stops the tape temporarily.
- 29 Stop button** (■) (☞ pg. 49)  
Stops playback of the tape.
- 30 Tripod mounting socket** (☞ pg. 15)
- 31 Multi connector (MULTI)** (☞ pg. 55)

## Docking Station

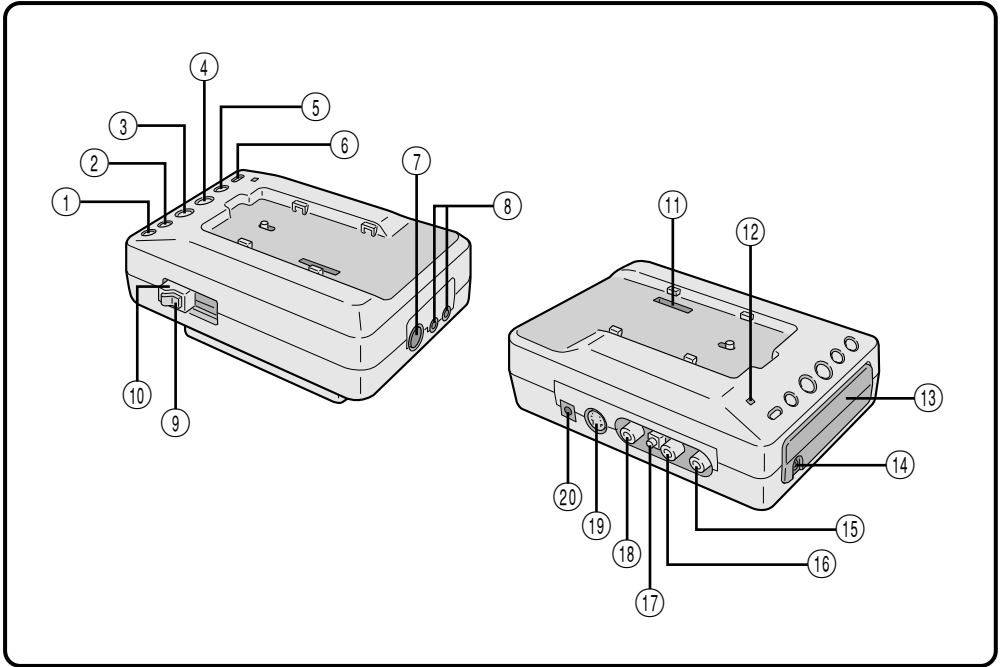

- ① **Fast-Forward (FF) button**
- ② **Rewing (REW) button** (☞ pg. 62)
- ③ **STOP button** (☞ pg. 58)
- ④ **PLAY button** (☞ pg. 58)
- ⑤ **PAUSE button** (☞ pg. 62)
- ⑥ **EDIT button** (☞ pg. 62)
- ⑦ **DIGITAL jack**
  - Connect to the computer's RS-232C terminal (COM port).
- ⑧ **JLIP jack (Joint Level Interface Protocol)**
  - Connect to a JLIP-compatible comcorder or VCR to control it from the computer.
- ⑨ **RELEASE button** (☞ pg. 55)
- ⑩ **LOCK lever** (☞ pg. 55)
- ⑪ **Multi connector** (☞ pg. 55)
  - The Docking Station can be connected with this camcorder through this connector. Never touch it with your hand or hit it with a hard object; if the pins are damaged, the connectors will become unusable due to contact failure.
- ⑫ **Charger Indicator (CHARGE)** (☞ pg. 55)
- ⑬ **Remote control sensor** (☞ pg. 60)
  - Receives the remote control signals for the attached Camcorder.
- ⑭ **EDIT jack** (☞ pg. 60)
- ⑮ **AUDIO OUT jack [R]** (☞ pg. 56)
- ⑯ **AUDIO OUT jack [L]** (☞ pg. 56)
- ⑰ **DC OUT jack**
  - For dealer use.
- ⑱ **VIDEO OUT jack** (☞ pg. 56)
- ⑲ **S-Video output jack (OUT)** (☞ pg. 56)
  - Outputs S-Video signal. (Also compatible with S, S1 and S2 connectors.)
- ⑳ **DC IN jack** (☞ pg. 56, 57)

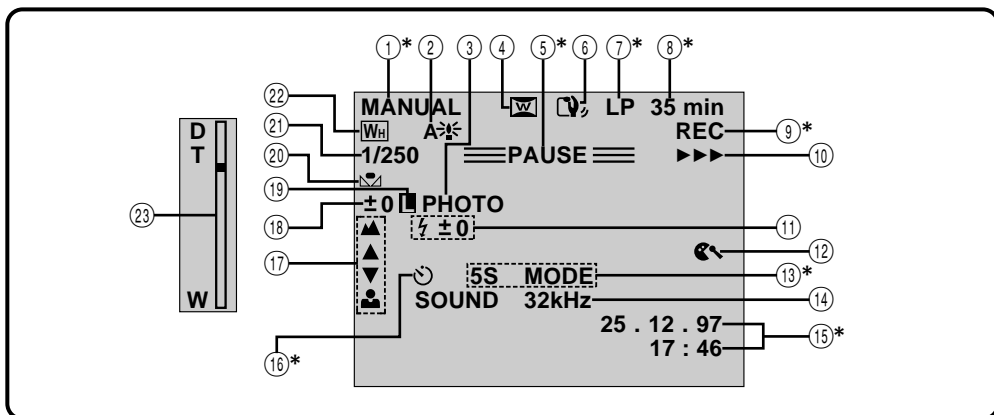

## LCD Monitor/Viewfinder Indications During Recording

No.	FUNCTION
①*	Displays the operation mode position. ( pg. 18)
②	Appears when GAIN UP is set to "AUTO A". ( pg. 32)
③	Appears when taking a snapshot. ( pg. 25)
④	Appears when in the Squeeze or Cinema mode. ( pg. 31)
⑤*	Appears when in the Record-Standby mode. ( pg. 19)
⑥	Appears when Digital Image Stabilizer is engaged. ( pg. 32)
⑦*	Displays the recording mode (SP or LP). ( pg. 13)
⑧*	Displays the tape remaining time. During Interface Shooting ( pg. 23), when the tape remaining time reaches 2 minutes, this indication is shown as follows;  2 min.  1 min.  0 min.
⑨*	Appears during recording.
⑩	Appears while the tape is running.
⑪	Appears when the flash is ready. A number appears next to the indication while adjusting the brightness of the flash. ( pg. 26, 27)
⑫	Appears when the wind cut mode is engaged to cut down on noise created by wind. ( pg. 35)
⑬*	Displays the 5 second mode recording or animation recording mode. ( pg. 28)
⑭	Displays the sound mode for approx. 5 seconds after turning on the camcorder. ( pg. 35)
⑮*	Displays the date/time. ( pg. 33)
⑯*	Appears during self-timer recording. ( pg. 29)
⑰	Appears when the focus is adjusted manually. ( pg. 44)
⑱	Appears when the exposure is adjusted. ( pg. 45)
⑲	Appears when the iris is locked. ( pg. 46)
⑳	Appears when the white balance is adjusted. ( pg. 47)
㉑	Displays the selected P.AE/Effect. ( pg. 42)
㉒	Displays the selected Fade/Wipe effect. ( pg. 36)
㉓	Appears during zooming. ( pg. 24)



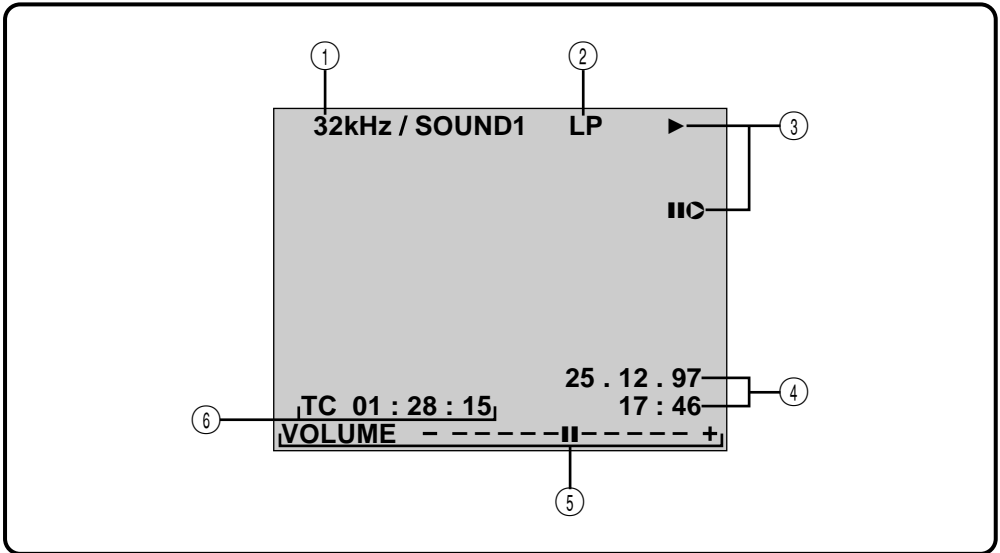



\* :Pressing IND. ON/OFF for longer than 1 second lets you remove indications marked with \* from the screen.

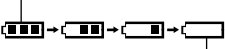

## LCD Monitor/Viewfinder Indications During Playback

No.	FUNCTION
①	Displays the sound mode. <span style="float: right;">(▶ pg. 53)</span>
②	Displays the recording mode of the tape being played back.
③	Appears while a tape is running. <ul style="list-style-type: none"> <li>▶ : Playback</li> <li>▶▶ : Fast-Forward/High-speed search</li> <li>◀◀ : Rewind/High-speed search</li> <li>▶▶▶ : Forward slow-motion</li> <li>▶▶◀ : Reverse slow-motion</li> <li>   : Pause</li> <li>◐ : Insert</li> <li>● : Audio Dubbing</li> </ul>
④	Displays the date/time. <span style="float: right;">(▶ pg. 53)</span>
⑤	Displays the brightness of the LCD monitor or the speaker volume. <span style="float: right;">(▶ pg. 22)</span>
⑥	Displays the time code. <span style="float: right;">(▶ pg. 53)</span>

## Warning Indications

INDICATIONS	FUNCTION
	<p>Displays the battery remaining power.</p> <p>Remaining power level: high </p> <p>Remaining power level: exhausted </p> <p>As the battery power comes close to nil, the battery indicator  blinks. When the battery power is exhausted, power turns off automatically.</p>
	<p>Appears when no tape is loaded, or when the erase protection tab is set to "SAVE". <span style="float: right;">(☞ pg. 12)</span></p>
	<p>Appears if dirt is detected on the heads during recording. (☞ pg. 80)</p>
	<p>Appears if condensation occurs. When this indication is displayed, the camcorder turns off automatically.</p>
<p><b>TAPE!</b></p>	<p>Appears for 10 seconds after power is turned on if there's no tape loaded.</p>
<p><b>TAPE END</b></p>	<p>Appears when the tape ends during recording or playback. <span style="float: right;">(☞ pg. 22)</span></p>
<p><b>SET DATE/TIME!</b></p>	<ul style="list-style-type: none"> <li>• Appears when the date/time is not set. <span style="float: right;">(☞ pg. 11)</span></li> <li>• Appears when the built-in rechargeable battery is discharged and the previously set date/time is erased. <span style="float: right;">(☞ pg. 11)</span></li> </ul>
<p><b>ERROR! REFER MANUAL</b></p>	<ul style="list-style-type: none"> <li>• Appears when Audio Dubbing is unavailable. <span style="float: right;">(☞ pg. 65)</span></li> <li>• Appears when Insert Editing is unavailable. <span style="float: right;">(☞ pg. 66)</span></li> </ul>
<p><b>E01 — E07</b></p>	<p>The error indications (E01 — E07) show what type of malfunction has occurred. When an error indication appears, the camcorder turns off automatically. Press the reset button after removing the power supply (battery, etc.), and wait a few minutes for the indication to clear. When it does, you can resume using the camcorder. If the indication remains, consult your nearest JVC dealer. <span style="float: right;">(☞ pg. 71)</span></p>

## Battery Packs

The supplied battery pack is a lithium-ion battery. Before using the supplied battery pack or an optional battery pack, be sure to read the following cautions:

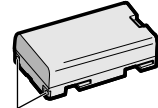

Terminals

1. **To avoid hazard . . .**
  - .... **do not** burn.
  - .... **do not** short-circuit the terminals.
  - .... **do not** modify or disassemble.
  - .... **do not** expose the battery to temperatures exceeding 60°C, as this may cause the battery to overheat, explode or catch fire.
  - .... use only specified chargers.
2. **To prevent damage and prolong service life . . .**
  - .... **do not** subject to unnecessary shock.
  - .... charge in an environment where temperatures are within the tolerances shown in the chart below. This is a chemical reaction type battery—cooler temperatures impede chemical reaction, while warmer temperatures can prevent complete charging.
  - .... store in a cool, dry place. Extended exposure to high temperatures will increase natural discharge and shorten service life.
  - .... fully charge and then fully discharge the battery once a year when storing the battery pack over a long period time.
  - .... remove from charger or powered unit when not in use, as some machines use current even when switched off.
3. **To prevent damage to the camcorder . . .**
  - .... replace the battery pack when it begins to deliver less recording time per charge.

## NOTES:

- *It is normal for the battery pack to be warm after charging, or after use.*
- |   |               |
|---|---------------|
| <b>Temperature Range Specifications</b> |               |
| Charging .....                          | 10°C to 35°C  |
| Operation .....                         | 0°C to 40°C   |
| Storage .....                           | -10°C to 30°C |
- *Recharging time is based on room temperature of 20°C.*
  - *The lower the temperature, the longer recharging takes.*

## Cassettes

To properly use and store your cassettes, be sure to read the following cautions:

1. **During use . . .**
  - .... make sure the cassette bears the Mini DV mark.
  - .... be aware that recording onto prerecorded tapes automatically erases the previously recorded video and audio signals.
  - .... make sure the cassette is positioned properly when inserting.
  - .... do not load and unload the cassette repeatedly without allowing the tape to run at all. This slackens the tape and can result in damage.
  - .... do not open the front tape cover. This exposes the tape to fingerprints and dust.
2. **Store cassettes . . .**
  - .... away from heaters or other heat sources.
  - .... out of direct sunlight.
  - .... where they won't be subject to unnecessary shock or vibration.
  - .... where they won't be exposed to strong magnetic fields (such as those generated by motors, transformers or magnets).
  - .... vertically, in their original cases.

## Main Unit

1. **For safety, DO NOT . . .**
  - .... open the camcorder's chassis.
  - .... disassemble or modify the unit.
  - .... short-circuit the terminals of the battery pack. Keep it away from metallic objects when not in use.
  - .... allow inflammables, water or metallic objects to enter the unit.
  - .... remove the battery pack or disconnect the power supply while the power is on.
  - .... leave the battery pack attached when the camcorder is not in use.
2. **Avoid using the unit . . .**
  - .... in places subject to excessive humidity or dust.
  - .... in places subject to soot or steam such as near a cooking stove.
  - .... in places subject to excessive shock or vibration.
  - .... near a television set.
  - .... near appliances generating strong magnetic or electric fields (speakers, broadcasting antennas, etc.).
  - .... in places subject to extremely high (over 40°C or 104°F) or extremely low (under 0°C or 32°F) temperatures.

3. **DO NOT leave the unit . . .**
  - .... in places of over 50°C (122°F).
  - .... in places where humidity is extremely low (below 35%) or extremely high (above 80%).
  - .... in direct sunlight.
  - .... in a closed car in summer.
  - .... near a heater.
4. **To protect the unit, DO NOT . . .**
  - .... allow it to become wet.
  - .... drop the unit or strike it against hard objects.
  - .... subject it to shock or excessive vibration during transportation.
  - .... keep the lens directed at extremely bright objects for long periods.
  - .... expose the lens to direct sunlight.
  - .... carry it by holding the LCD monitor or the viewfinder.
  - .... swing it excessively when using the hand strap or the grip.
  - .... swing the soft camera case excessively when the camcorder is inside it.
5. **Dirty heads can cause the following problems:**

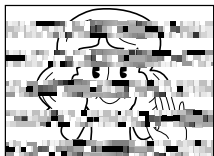

- No picture during playback.
- Blocks of noise appear during playback.
- During recording, the Head Clog Warning indicator "⊗" appears.

In such cases, use the optional Cleaning Cassette. Insert it and play back. If the cassette is used more than once consecutively, damage to the video heads may result. After the camcorder plays back for about 20 seconds, it stops automatically. Also refer to the Cleaning Cassette's instructions.

If, after using the Cleaning Cassette, the problems still exist, consult your nearest JVC dealer.

Mechanical moving parts used to move the video heads and video tape tend to become dirty and worn out over time. In order to maintain a clear picture at all times, periodic check-ups are recommended after using the unit for about 1,000 hours. For periodic check-ups please consult your nearest JVC dealer.

## LCD monitor

1. **To prevent damage to the LCD monitor, DO NOT . . .**
  - .... push it strongly or apply any shocks.
  - .... place the camcorder with the LCD monitor on the bottom.
2. **To prolong service life . . .**
  - .... avoid rubbing it with coarse cloth.
3. **Be aware of the following phenomena for LCD monitor use.**  
**These are not malfunctions. . . .**
  - While using the camcorder, the surface around the LCD monitor and/or the back of the LCD monitor may heat up.
  - If you leave power on for a long time, the surface around the LCD monitor becomes hot.

### About moisture condensation . . .

- You have observed that pouring a cold liquid into a glass will cause drops of water to form on the glass' outer surface. This same phenomenon occurs on the head drum of a camcorder when it is moved from a cool place to a warm place, after heating a cold room, under extremely humid conditions or in a place directly subjected to the cool air from an air conditioner.
- Moisture on the head drum can cause severe damage to the video tape, and can lead to internal damage to the camcorder itself.

### Serious malfunctioning

If malfunctioning occurs, stop using the unit immediately and consult your local JVC dealer.

The camcorder is a microcomputer-controlled device. External noise and interference (from a TV, a radio, etc.) might prevent it from functioning properly. In such cases, first disconnect its power supply unit (battery pack, AC Power Adapter/Battery Charger, etc.) and press the RESET button and then re-connect it and proceed as usual from the beginning.



**CAMCORDER****General**

<b>Power</b>	: DC 6.3 V $\overline{\text{---}}$ (using AC Adapter) DC 7.2 V $\overline{\text{---}}$ (using Battery)
<b>Power consumption</b>	: 6.2 W (viewfinder on), 7.0 W (LCD monitor on)
<b>Format</b>	: DV Format (SD mode)
<b>Signal format</b>	: PAL Standard
<b>Video signal recording format</b>	: Digital Component Recording
<b>Cassette</b>	: MINI DV Cassette
<b>Tape Speed</b>	: SP: 18.8 mm/sec. LP: 12.5 mm/sec.
<b>Maximum recording time</b>	: SP: 60 min. LP: 90 min. (using DVM-60 cassette)
<b>Pickup</b>	: 1/3" CCD
<b>Lens</b>	: F1.6, f = 4.5 to 45 mm, 10:1 Power Zoom Lens
<b>Filter diameter</b>	: $\varnothing$ 27 mm
<b>LCD monitor</b>	: 2.5", 180,000 pixel polysilicon TFT/LCD panel
<b>Viewfinder</b>	: 0.55" colour LCD
<b>Operating temperature</b>	: 0 to 40°C
<b>Operating humidity</b>	: 35 to 80%
<b>Storage temperature</b>	: -20 to 50°C
<b>Dimensions</b>	: 49 (W) x 131 (H) x 93 (D) mm
<b>Weight</b>	: Approx. 590 g (incl. cassette and battery)

**Video**

<b>Output</b>	: 1 V <sub>p-p</sub> , 75 $\Omega$ unbalanced, analogue output (via $\varnothing$ 3.5 mm AV output jack)
---------------	---

**Audio**

<b>Output</b>	: -8 dBs, 1 k $\Omega$ analogue output (via $\varnothing$ 3.5 mm AV output jack)
<b>Headphone</b>	: stereo (via $\varnothing$ 3.5 mm AV output jack)
<b>External microphone input</b>	: -62 dBs, high impedance unbalanced with $\varnothing$ 3.5 mm (STEREO)
<b>Speaker</b>	: 20 mm round x 1, monaural

**AC ADAPTER/CHARGER**

<b>Power</b>	: AC 110-240 V $\sim$ , 50/60 Hz
<b>Power consumption</b>	: 20 W
<b>Output power</b>	: DC 7.2 V $\overline{\text{---}}$ , 0.75 A (charge) DC 6.3 V $\overline{\text{---}}$ , 1.8 A (VTR)
<b>Operating temperature</b>	: 0°C to 40°C (when charging, 10°C to 35°C)
<b>Dimensions</b>	: 94 mm (W) x 36 mm (H) x 122 mm (D)
<b>Weight</b>	: Approx. 380 g

\* Specifications shown are for SP mode unless otherwise indicated. E & O.E. Design and specifications subject to change without notice.

**Iris**

Works like the pupil of the human eye. In a well-lit environment, the human pupil contracts to keep too much light from entering. In low lighting, the pupil dilates to allow more light in.

**Colour temperature**

A measurement in Kelvin degrees which indicates the colour contents of a light source; bluish light has a higher colour temperature than reddish light. To reproduce white as white under different types of lighting, the chrominance signal must be adjusted to match the light source's colour temperature. (See "White Balance".)

**AC Adapter**

Used when charging the battery. Or, when connected directly to the camcorder, it can be used as a power supply.

**Auto focus**

Focus can be set for automatic adjustment, for beginners who find the adjustment difficult.

**On-screen display**

Displays in the viewfinder or the LCD monitor can be shown on a connected TV.

**Strobe**

In the early days of movie making, 1-second strobes were uncommon, so movies didn't have the smooth movement they have today. This function gives movies the old-film flicker effect.

**Record-Standby**

Engage this mode by pressing START/STOP during Stop or Record modes. It means that the camcorder, or your VCR, is paused and ready to record.

**CCD (Charge coupled device)**

Solid-state imaging device used in camcorders as the camera's image pickup; analogous to the eye's retina except that picture information is output as electric signals.

**Dew sensor**

If condensation forms inside the unit due to a temperature change, the indicator appears in the viewfinder or the LCD monitor, and the camcorder becomes unusable.

**Digital zoom**

10X Optical zoom image is taken and digitally processed to provide 20X or 100X magnified images.

**Digital Image Stabilizer**

When shooting while holding the camcorder in your hand, even if you think you're perfectly still, there is slight movement. This function compensates for that movement.

**Fade**

An effect used in scene transitions. Like movies or TV, the scene gradually goes black or white (fade out), or comes in from a black or white screen (fade in).





**White balance**

A term that refers to the correctness of colour reproduction under various lighting. If the white balance is correct, all other colours will be accurately reproduced.



**Wipe**

An effect used in scene transitions. A scene disappears as though it's being wiped off the screen (wipe out), or appears as though it's wiped on (wipe in).

**A**

- Animation .....  pg. 35
- Audio Dubbing .....  pg. 65
- Auto Focus .....  pg. 44
- Auto Shut off .....  pg. 19







**B**

- Battery .....  pg. 8
- Battery Low .....  pg. 78
- Beep/Tally .....  pg. 35

**C**

- Charging .....  pg. 8
- Cleaning The Camcorder .....  pg. 72
- Connections .....  pg. 10, 54 – 57





**D**

- Date/Time Display .....  pg. 33, 53
- Date/Time Settings .....  pg. 11
- Digital Image Stabilizer .....  pg. 32
- Digital Zoom .....  pg. 24
- Docking Station .....  pg. 55
- Dubbing .....  pg. 58



**E**

- Editing .....  pg. 58
- Exposure Control .....  pg. 45

**F**

- 5SD .....  pg. 28
- 5-Second Mode .....  pg. 28
- Fade-In/Out .....  pg. 37
- Flash .....  pg. 26
- Focus Adjustment.....  pg. 44

**I**

- Insert Editing .....  pg. 66
- Iris .....  pg. 46
- Iris Lock .....  pg. 46



**L**

- LCD monitor/Viewfinder indications .....  pg. 76 – 78
- Lithium Battery .....  pg. 2, 4, 79
- Loading A Tape .....  pg. 12





**M**

- Motor Drive Mode .....  pg. 25





**O**

- On-Screen Menus .....  pg. 30 – 35, 52, 53
- Operation Mode .....  pg. 18









**P**

- P.AE/Effects .....  pg. 42, 43
- Photo Frame .....  pg. 35
- Playback Zoom .....  pg. 50
- Power (AC/Battery) .....  pg. 9, 10



**R**

- Random Assemble Editing .....  pg. 60 – 64
- Record Safety Tab .....  pg. 12
- Record-Standby .....  pg. 19
- Recording Format .....  pg. 6
- Remote Control .....  pg. 17

**S**

- Self-Timer .....  pg. 29
- Set VCR Brand .....  pg. 59
- Shutter/Slow shutter .....  pg. 43
- Slow Motion Playback .....  pg. 49
- Snapshot Mode .....  pg. 25
- Sound Mode .....  pg. 35
- Squeeze .....  pg. 31
- Still Playback .....  pg. 49
- Strobe .....  pg. 43

**T**

- Tapes .....  pg. 12
- Time Code .....  pg. 6, 21

**W**

- White Balance .....  pg. 47, 48
- Wide Mode .....  pg. 31
- Wipe In/Out .....  pg. 37

